



FABRICANT
CLIPS SOLAIRES
DEPUIS 1947

CATALOGUE 2024

CLIPS SOLAIRES



CLIP - ON
RESSORT



CLIP - ON
REGLABLES



FACES
RELEVABLES



CLIPS
UNIVERSELS

VERRES BASE 6

POLYCARBONATE



Verre Jaune (V): pour la conduite, tir, ski. Augmente le contraste et la luminosité.

ORGANIQUE



Verre Jaune Antiphare (W): pour la conduite de nuit. Atténue l'éblouissement des phares.
Verre Ordinateur (O): pour écran ordinateur et télévision.
Verre Brun Cat. 1 (AC): usage d'intérieur.

POLARISANT TAC (TRICÉTATE)

Découpable aux ciseaux.



Verre Jaune (T): pour la conduite, tir, ski. Atténue les reflets, augmente le contraste et la luminosité.
Verre Jaune Fishing (U): pour la pêche. Atténue les reflets.

ORGANIQUE BASSE VISION



POLYCARBONATE BASSE VISION



ORGANIQUE-POLARISANT



BLUE-BLOCKER SPÉCIAL LUMIÈRE BLEUE



CARACTÉRISTIQUES DES VERRES

Caractéristiques de nos faces relevables et types de verres:

- 1 Les faces relevables sont montées dans nos ateliers avec montage vissé (possibilité de changer de verre).
- 2 Choix de tailles et couleurs.
- 3 **Verre Organique:** épaisseur 1.80 mm taillable sur meule.

Verre Polycarbonate: épaisseur 2.00 mm taillable sur meule.

Verre Polarisant TAC: épaisseur 0.75 mm découpable aux ciseaux.

Verre Polarisant-Organique: épaisseur 2.00 mm taillable sur meule.

Categorie de filtre	Description	Domaine de transmission lumineuse		Usage recommandé
		De %	À %	
0	Teinte claire ou très légère	80	100	Pour des raisons cosmétiques ou pour utilisation sous une lumière faible/moyenne
1	Teinte légère	43	80	
2	Teinte sombre	18	43	Pour une utilisation générale sous un soleil rayonnant et sous une lumière crue
3	Teinte sombre	8	18	
4	Teinte très sombre	3	8	Ne convient pas à la conduite et à une utilisation sur route

SURLUNETTES

Surlunettes avec verres au choix.
Avec pochette tissu.
Esthétique, légère, confortable.

Réf. 316



Pochette
tissu



Choisissez
vos verres

LES LUNETTES
DE SOLEIL QUI FONT
SURLUNETTES



Étui rigide

RÉF. 322N

Monture noire.
Taille 61-14.



L 136

Ht 40 mm



RÉF. 322E

Monture écaille.
Taille 61-14.



RÉF. 323E

Monture écaille.
Taille 61-13.



L 135

Ht 42 mm



RÉF. 323N

Monture noire.
Taille 61-13.



RÉF. 324E

Monture écaille.
Taille 60-14.



L 134

Ht 39 mm



RÉF. 324N

Monture noire.
Taille 60-14.



RÉF. 325N

Monture noire.
Taille 62-14.



L 138

Ht 43 mm



RÉF. 325E

Monture écaille.
Taille 62-14.



RÉF. 326E

Monture écaille.
Taille 65-16.



RÉF. 326N

Monture noire.
Taille 65-16.



RÉF. 327N

Monture noire.
Taille 66-20.



RÉF. 327E

Monture écaille.
Taille 66-20.



RÉF. 315

Monture noire.
Taille 55-22.



RÉF. 316

Monture noire.
Taille 61-18.



OFFERT PRÉSENTOIR

Présentoir aide à la vente.
Offert pour une commande de 12 pièces.

Disponible dans tous les verres figurant ci-dessous
POLYCARBONATE

MIROIR
CAT3
AR

ORGANIQUE

- | | | | | | | | | |
|---------------------|------------------|----------------------|---------------------|------------------|------------------|--------------------|--------------------------|------------------|
| BLANC
CAT0
AL | MA
CAT1
AC | ORANGE
CAT2
AD | JAUNE
CAT0
AS | DEG
CAT2
X | DEG
CAT2
Z | ORDI.
CAT2
O | ANTI-PRISME
CAT1
W | MB
CAT2
AM |
| GB
CAT2
AN | MC
CAT3
F | G15
CAT3
L | GC
CAT3
M | MD
CAT4
N | GD
CAT4
P | | | |

ORGANIQUE-POLARISANT

- | | | | |
|------------------|-------------------|------------------|------------------|
| MC
CAT3
AA | G15
CAT3
AB | GC
CAT3
AO | GD
CAT4
AX |
|------------------|-------------------|------------------|------------------|

BASSE VISION ORGANIQUE

- | | | | |
|---------------------|---------------------|---------------------|---------------------|
| 450 NM
CAT1
G | 511 NM
CAT1
H | 527 NM
CAT1
I | 550 NM
CAT2
Y |
|---------------------|---------------------|---------------------|---------------------|

ORGANIQUE BLUE-BLOCKER (LUMIÈRE BLEUE)

CATO
AY

**VERRES
AU CHOIX**



TINYCLIP

CLIPS UNIVERSELS POLARISANTS

Clip universel polarisant à griffe nasale prenant sur le pont de la monture. Avec étui rigide. A retoucher avec des ciseaux (si nécessaire). Simple et rapide.



≈ 0.75 mm
découpable
aux ciseaux

Avec étui rigide



Système nez métallique avec
crochets recouverts de gaine
plastique antidérapante

Crochets
avec gaine
antidérapante

RÉF. 260 - 263 - 265 - 266

Votre Clip déjà monté en verres polarisants cat. 3.
Pour montures métal.

Quatre formes disponibles:

POLARISANT TAC



RÉF. 260Q

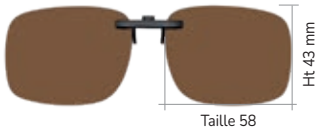

RÉF. 260S



RÉF. 263Q

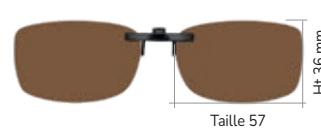

RÉF. 263S



RÉF. 265Q

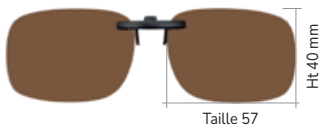

RÉF. 265S



RÉF. 266Q

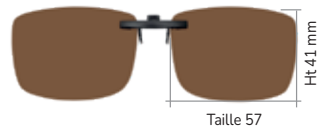

RÉF. 266S





POLYCLIP

CLIPS UNIVERSELS POLARISANTS

Clip universel polarisant à griffe nasale prenant sur le verre. Avec étui rigide.
A retoucher avec des ciseaux (si nécessaire).
Simple et rapide.



≤ 0.75 mm
découpable
aux ciseaux

Avec étui rigide



Système nez
métallique avec
crochets recouverts
de gaine plastique
antidérapante

Crochets
avec gaine
antidérapante

RÉF. 160 - 162 - 163 - 164 - 165 166 - 167 - 168 - 169 - 170

Votre Clip déjà monté en verres polarisants Cat. 3 et jaune Cat. 1. Pour monture métal et plastique.

Dix formes disponibles:

POLARISANT TAC



RÉF. 160Q

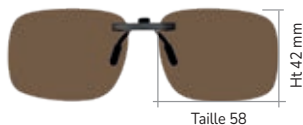

RÉF. 160R



RÉF. 160S



RÉF. 160T



RÉF. 162Q

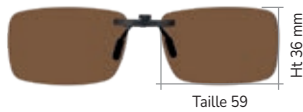

RÉF. 162R



RÉF. 163Q

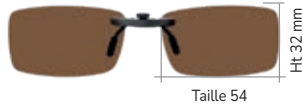

RÉF. 163R



RÉF. 164Q

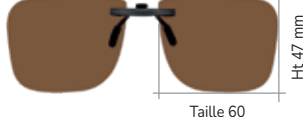

RÉF. 164S

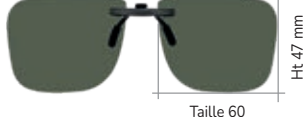

RÉF. 165Q

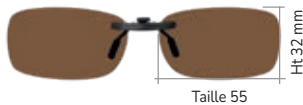

RÉF. 165R



RÉF. 166Q Tailles 55

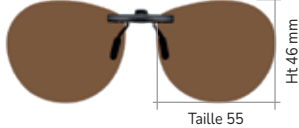

RÉF. 166Q Tailles 57

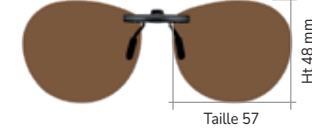

RÉF. 166S Tailles 55



RÉF. 166S Tailles 57



RÉF. 166R Tailles 55



RÉF. 166R Tailles 57



RÉF. 166T Tailles 57

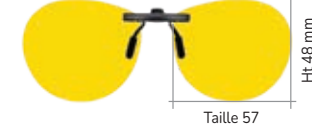

TAILLE

T. 55 Dimensions: L 55 mm - H 46 mm

T. 57 Dimensions: L 57 mm - H 48 mm

RÉF. 167Q

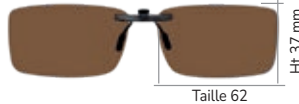

RÉF. 167R



RÉF. 168Q

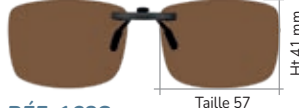

RÉF. 168R



RÉF. 168S



RÉF. 169Q

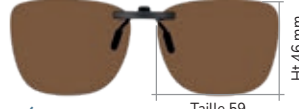

RÉF. 169R

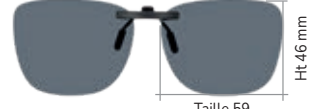

RÉF. 169S



RÉF. 170Q

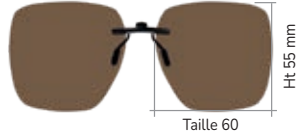

RÉF. 170S

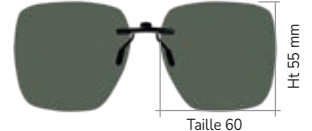

CLIP - ON RESSORT POLARISANTS

Avec étui souple. **Minimum 6 pièces au choix.**
Possibilité de panacher dans les références.



Réf. 453G



Ressort
discret



Étui souple



RÉF. 420G

Gun - G15 Cat. 3.
Tailles 48 - 50 - 52.

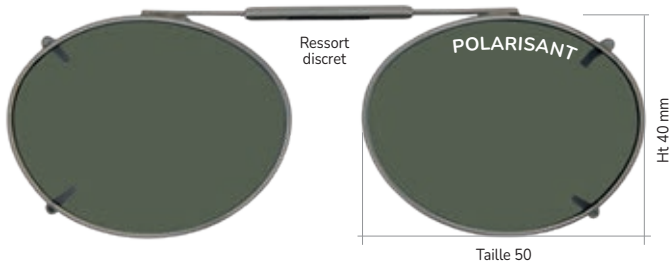

RÉF. 420N

Noir - MC Cat. 3.
Tailles 48 - 50 - 52.

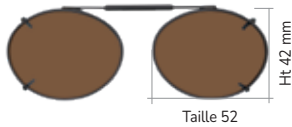

TAILLE

T. 48 Dimensions: L 48 mm - H 38 mm
T. 50 Dimensions: L 50 mm - H 40 mm
T. 52 Dimensions: L 52 mm - H 42 mm

RÉF. 432N

Noir - MC Cat. 3.
Tailles 53 - 55 - 57.

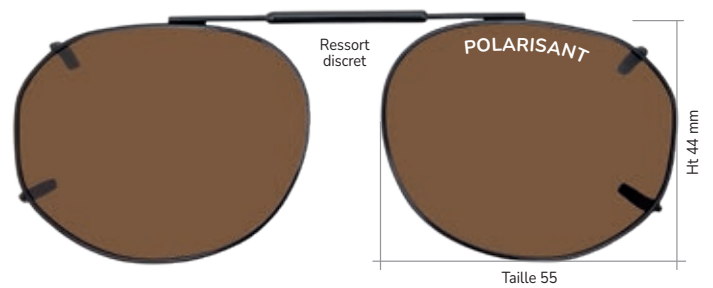

RÉF. 432G

Gun - G15 Cat. 3.
Tailles 53 - 55 - 57.

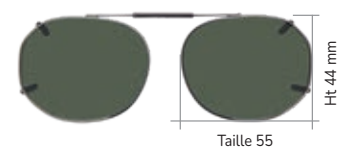

TAILLE

T. 53 Dimensions: L 53 mm - H 42 mm
T. 55 Dimensions: L 55 mm - H 44 mm
T. 57 Dimensions: L 57 mm - H 46 mm

RÉF. 442G

Gun - G15 Cat. 3.
Tailles 50 - 53 - 55.

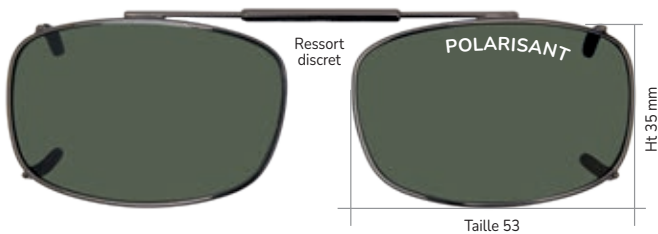

RÉF. 442N

Noir - MC Cat. 3.
Tailles 50 - 53 - 55.

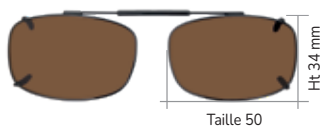

TAILLE

T. 50 Dimensions: L 50 mm - H 34 mm
T. 53 Dimensions: L 53 mm - H 35 mm
T. 55 Dimensions: L 55 mm - H 36 mm

RÉF. 454N

Noir - MC Cat. 3.
Tailles 48 - 50 - 52.

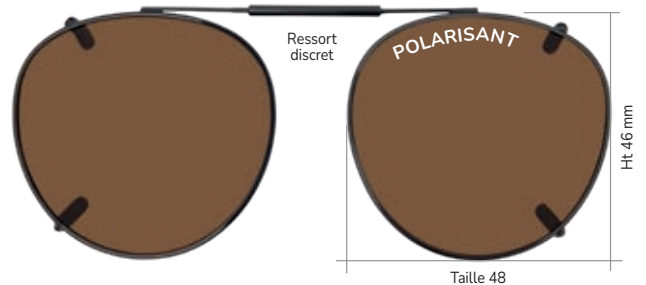

RÉF. 454G

Gun - G15 Cat. 3.
Tailles 48 - 50 - 52.

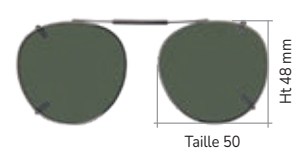

TAILLE

T. 48 Dimensions: L 48 mm - H 46 mm
T. 50 Dimensions: L 50 mm - H 48 mm
T. 52 Dimensions: L 52 mm - H 50 mm

CLIP - ON RESSORT

Gun / G15 et Noir / MC Cat. 3. Avec étui souple. **Minimum 6 pièces au choix.**
Possibilité de panacher dans les références.



Étui souple

RÉF. 419G

Gun - G15 Cat. 3.
Tailles 48.

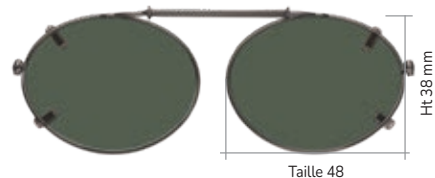

TAILLE

T. 48 Dimensions: L 48 mm - H 38 mm

RÉF. 452G

Gun - Gris Cat. 3.
Tailles 54 - 58 - 60.

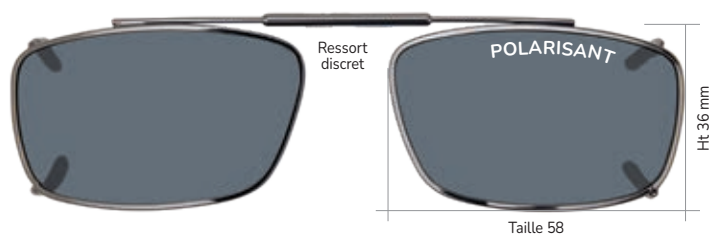

RÉF. 452N

Noir - MC Cat. 3.
Tailles 54 - 58 - 60.

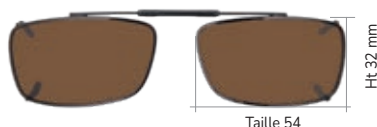

TAILLE

T. 54 Dimensions: L 54 mm - H 32 mm
T. 58 Dimensions: L 58 mm - H 36 mm
T. 60 Dimensions: L 60 mm - H 38 mm

RÉF. 431N

Noir - MC Cat. 3.
Tailles 53.

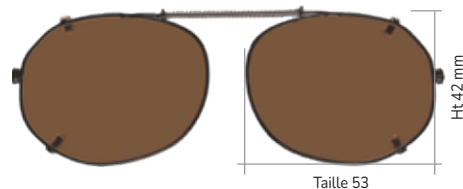

TAILLE

T. 53 Dimensions: L 53 mm - H 42 mm

RÉF. 441G

Gun - G15 Cat. 3.
Tailles 48.

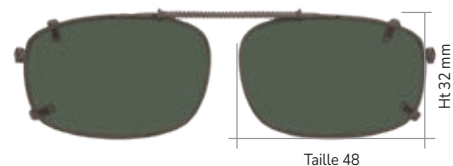

RÉF. 441N

Noir - MC Cat. 3.
Tailles 48 - 50.

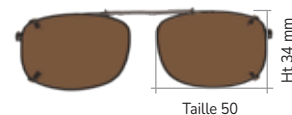

TAILLE

T. 48 Dimensions: L 48 mm - H 32 mm
T. 50 Dimensions: L 50 mm - H 34 mm

RÉF. 453G

Gun - Gris Cat. 3.
Tailles 54 - 57.

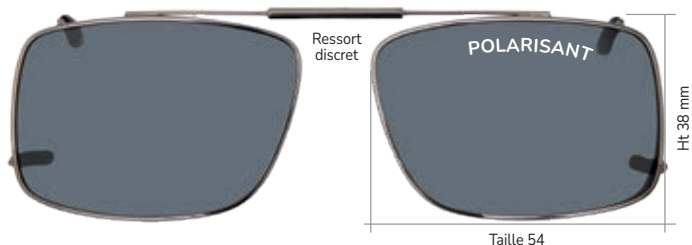

RÉF. 453N

Noir - MC Cat. 3.
Tailles 54 - 57.

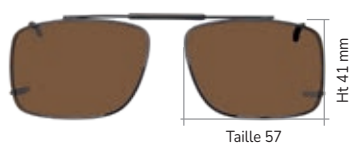

TAILLE

T. 54 Dimensions: L 54 mm - H 38 mm
T. 57 Dimensions: L 57 mm - H 41 mm

RÉF. 461G

Gun - G15 Cat. 3.
Tailles 55 - 58.

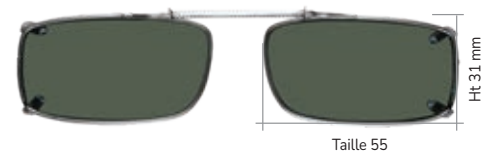

RÉF. 461N

Noir - MC Cat. 3.
Tailles 55 - 58.

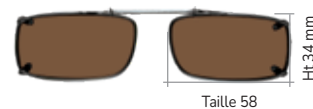

TAILLE

T. 55 Dimensions: L 55 mm - H 31 mm
T. 58 Dimensions: L 58 mm - H 34 mm

CLIP - ON REGLABLES

En doré, noir ou ruthénium. Avec étui souple.
Possibilité de panacher dans les références.



Fabrication
Française



Étui souple



Étui rigide
transparent



Réf. 121



Réglable



Choisissez
vos verres



RÉF 119N

Ovale. Monture métal noir. Tailles 42 - 44 - 46 - 48 - 50 - 52 - 54.

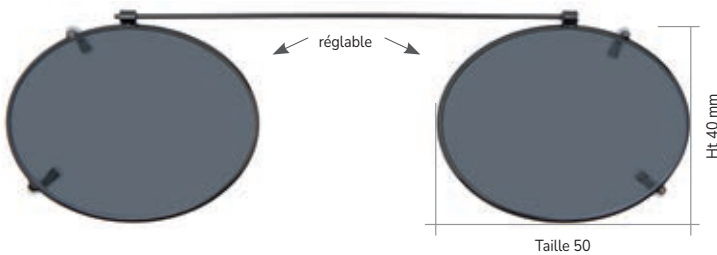

RÉF 119R

Monture métal ruthénium.



RÉF 119D

Monture métal doré.



TAILLE

T. 42 Dimensions: L 42 mm - H 32 mm
T. 44 Dimensions: L 44 mm - H 34 mm
T. 46 Dimensions: L 46 mm - H 36 mm
T. 48 Dimensions: L 48 mm - H 38 mm

T. 50 Dimensions: L 50 mm - H 40 mm
T. 52 Dimensions: L 52 mm - H 42 mm
T. 54 Dimensions: L 54 mm - H 44 mm

RÉF 121R

Pantos. Monture métal ruthénium. Tailles 44 - 46 - 48 - 50 - 52 - 54 - 56.

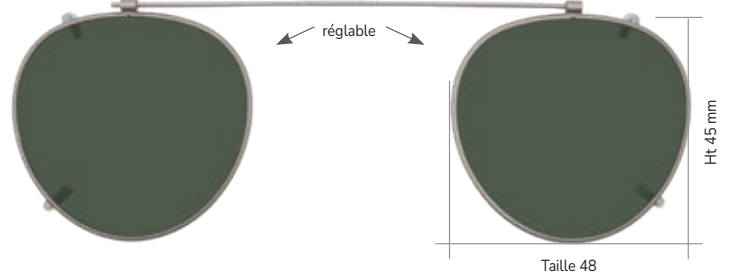

RÉF 121D

Monture métal doré.



RÉF 121N

Monture métal noir.



TAILLE

T. 44 Dimensions: L 44 mm - H 41 mm
T. 46 Dimensions: L 46 mm - H 43 mm
T. 48 Dimensions: L 48 mm - H 45 mm
T. 50 Dimensions: L 50 mm - H 47 mm

T. 52 Dimensions: L 52 mm - H 49 mm
T. 54 Dimensions: L 54 mm - H 51 mm
T. 56 Dimensions: L 56 mm - H 53 mm

RÉF 120D

Rond. Monture métal doré. Tailles 40 - 42 - 44 - 46 - 48 - 50 - 52.

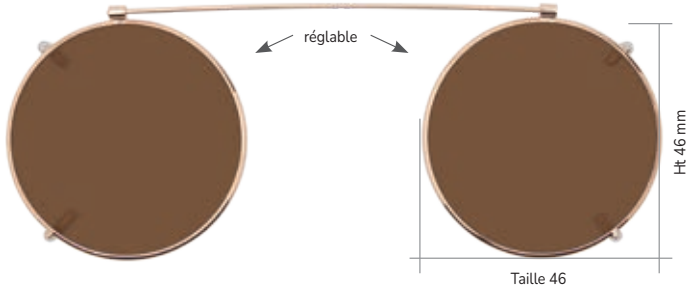

RÉF 120N

Monture métal noir.



RÉF 120R

Monture métal ruthénium.



TAILLE

T. 40 Dimensions: L 40 mm - H 40 mm
T. 42 Dimensions: L 42 mm - H 42 mm
T. 44 Dimensions: L 44 mm - H 44 mm
T. 46 Dimensions: L 46 mm - H 46 mm

T. 48 Dimensions: L 48 mm - H 48 mm
T. 50 Dimensions: L 50 mm - H 50 mm
T. 52 Dimensions: L 52 mm - H 52 mm

RÉF 131N

Carré. Monture métal noir. Tailles 52 - 54 - 56 - 58.

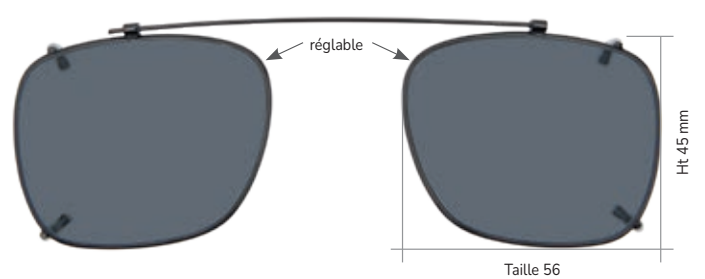

RÉF 131R

Monture métal ruthénium.



RÉF 131D

Monture métal doré.



TAILLE

T. 52 Dimensions: L 52 mm - H 41 mm
T. 54 Dimensions: L 54 mm - H 43 mm

T. 56 Dimensions: L 56 mm - H 45 mm
T. 58 Dimensions: L 58 mm - H 47 mm

RÉF 141N

Rectangle. Monture métal noir. Tailles 46 - 48 - 50 - 52 - 54 - 56 - 58.

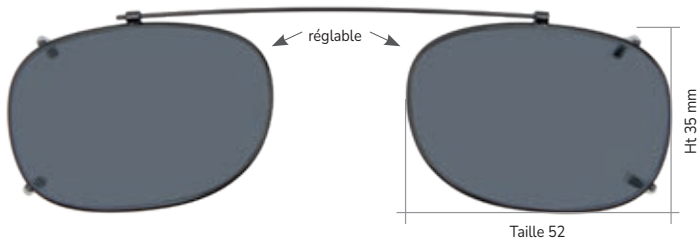

RÉF 141R

Monture métal ruthénium.



RÉF 141D

Monture métal doré.



TAILLE

T. 46 Dimensions: L 46 mm - H 29 mm
 T. 48 Dimensions: L 48 mm - H 31 mm
 T. 50 Dimensions: L 50 mm - H 33 mm
 T. 52 Dimensions: L 52 mm - H 35 mm

T. 54 Dimensions: L 54 mm - H 37 mm
 T. 56 Dimensions: L 56 mm - H 39 mm
 T. 58 Dimensions: L 58 mm - H 41 mm

RÉF 171D

Rectangle. Monture métal doré. Taille 58.

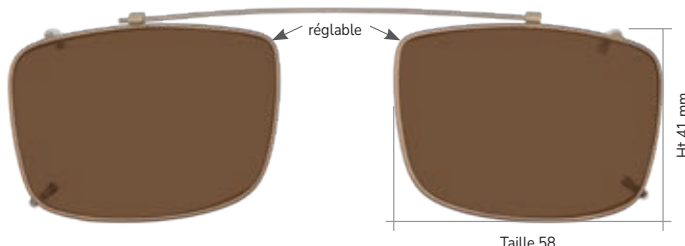

RÉF 171N

Monture métal noir.



RÉF 171R

Monture métal ruthénium.



TAILLE

T. 58 Dimensions: L 58 mm - H 41 mm

RÉF 151D

Tonneau. Monture métal doré. Tailles 50 - 52 - 54 - 56.

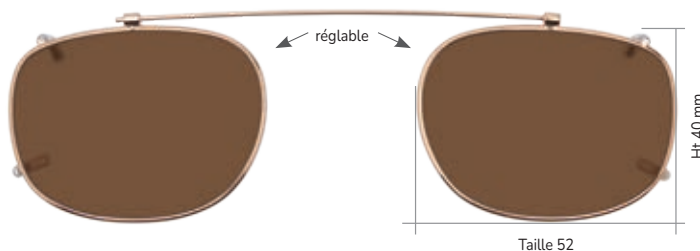

RÉF 151N

Monture métal noir.



RÉF 151R

Monture métal ruthénium.



TAILLE

T. 50 Dimensions: L 50 mm - H 38 mm
 T. 52 Dimensions: L 52 mm - H 40 mm

T. 54 Dimensions: L 54 mm - H 42 mm
 T. 56 Dimensions: L 56 mm - H 44 mm

RÉF 161R

Rectangle. Monture métal ruthénium. Tailles 52 - 54 - 56 - 58.

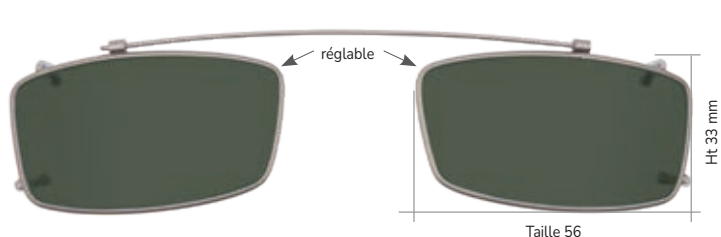

RÉF 161D

Monture métal doré.



RÉF 161N

Monture métal noir.



TAILLE

T. 52 Dimensions: L 52 mm - H 29 mm
 T. 54 Dimensions: L 54 mm - H 31 mm

T. 56 Dimensions: L 56 mm - H 33 mm
 T. 58 Dimensions: L 58 mm - H 35 mm



Disponible dans tous les verres figurant ci-dessous

POLYCARBONATE



AR

ORGANIQUE



BASSE VISION ORGANIQUE



ORGANIQUE BLUE-BLOCKER (LUMIÈRE BLEUE)



AY

FASTCLIP

FACES RELEVABLES

Montage vissé. Avec étui souple.
Verres au choix. Possibilité de panacher
dans les références.



Fabrication
Française



Système relevable
(Minimum 6 pièces)



Étui souple



Étui rigide

CHOISISSEZ
VOS
VERRES



RÉF. 115

Tailles 50 - 52 - 54 - 56 - 58 - 60 - 62.

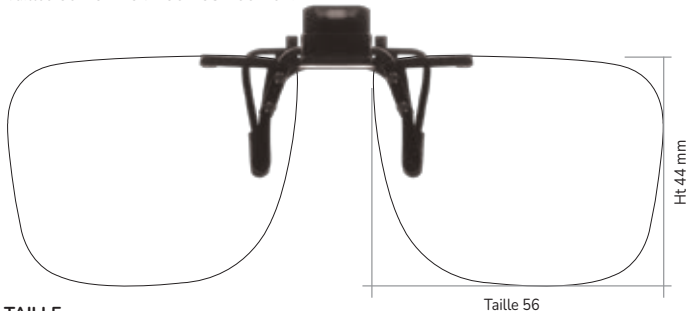

TAILLE

T. 50 Dimensions: L 50 mm - H 38 mm
T. 52 Dimensions: L 52 mm - H 40 mm
T. 54 Dimensions: L 54 mm - H 42 mm
T. 56 Dimensions: L 56 mm - H 44 mm

T. 58 Dimensions: L 58 mm - H 46 mm
T. 60 Dimensions: L 60 mm - H 48 mm
T. 62 Dimensions: L 62 mm - H 50 mm

RÉF. 118

Tailles 50 - 52 - 54 - 56 - 58 - 60 - 62.

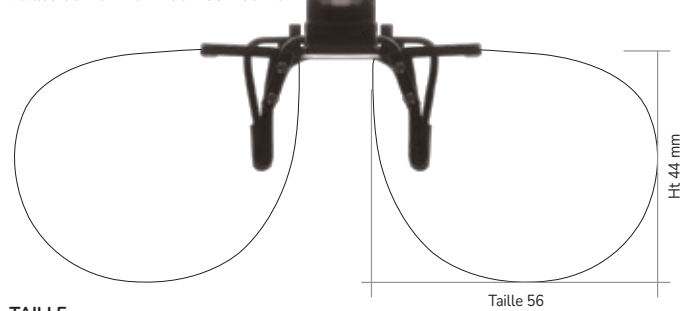

TAILLE

T. 50 Dimensions: L 50 mm - H 37 mm
T. 52 Dimensions: L 52 mm - H 39 mm
T. 54 Dimensions: L 54 mm - H 41 mm
T. 56 Dimensions: L 56 mm - H 44 mm

T. 58 Dimensions: L 58 mm - H 46 mm
T. 60 Dimensions: L 60 mm - H 48 mm
T. 62 Dimensions: L 62 mm - H 50 mm

RÉF. 116

Tailles 55 - 57 - 60.

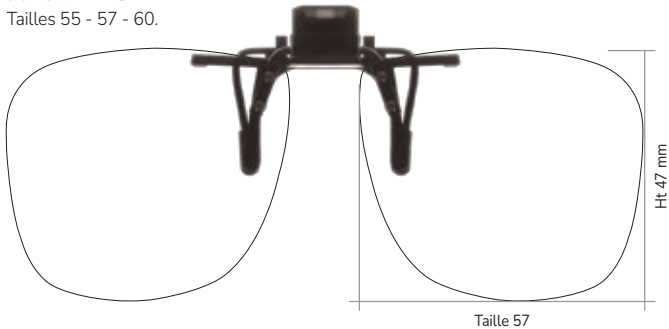

TAILLE

T. 55 Dimensions: L 55 mm - H 45 mm
T. 57 Dimensions: L 57 mm - H 47 mm

T. 60 Dimensions: L 60 mm - H 50 mm

RÉF. 125

Tailles 52 - 54 - 56 - 58 - 60 - 62.

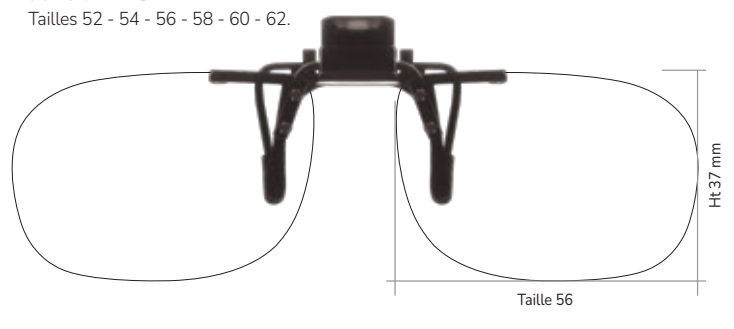

TAILLE

T. 52 Dimensions: L 52 mm - H 33 mm
T. 54 Dimensions: L 54 mm - H 35 mm
T. 56 Dimensions: L 56 mm - H 37 mm

T. 58 Dimensions: L 58 mm - H 39 mm
T. 60 Dimensions: L 60 mm - H 41 mm
T. 62 Dimensions: L 62 mm - H 43 mm

RÉF. 127

Tailles 52 - 54 - 56 - 58 - 60 - 62.

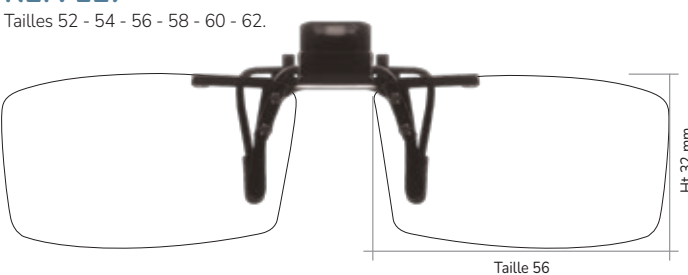

TAILLE

T. 52 Dimensions: L 52 mm - H 28 mm
T. 54 Dimensions: L 54 mm - H 30 mm
T. 56 Dimensions: L 56 mm - H 32 mm

T. 58 Dimensions: L 58 mm - H 34 mm
T. 60 Dimensions: L 60 mm - H 36 mm
T. 62 Dimensions: L 62 mm - H 38 mm

RÉF. 128

Tailles 51 - 53 - 55 - 57 - 59 - 61.

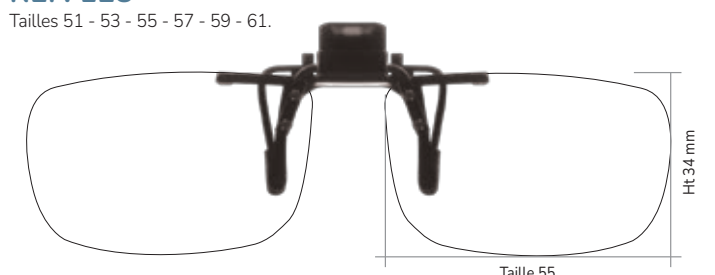

TAILLE

T. 51 Dimensions: L 51 mm - H 30 mm
T. 53 Dimensions: L 53 mm - H 32 mm
T. 55 Dimensions: L 55 mm - H 34 mm

T. 57 Dimensions: L 57 mm - H 36 mm
T. 59 Dimensions: L 59 mm - H 38 mm
T. 61 Dimensions: L 61 mm - H 40 mm



Réf. 115



RÉF. 129

Tailles 52 - 54 - 56 - 58 - 60 - 62.

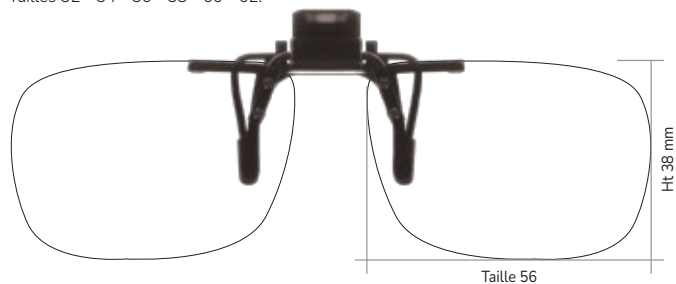

- TAILLE**
T. 52 Dimensions: L 52 mm - H 34 mm
T. 54 Dimensions: L 54 mm - H 36 mm
T. 56 Dimensions: L 56 mm - H 38 mm

- T. 58** Dimensions: L 58 mm - H 40 mm
T. 60 Dimensions: L 60 mm - H 42 mm
T. 62 Dimensions: L 62 mm - H 44 mm

RÉF. 132

Tailles 52 - 54 - 56 - 58 - 60 - 62.

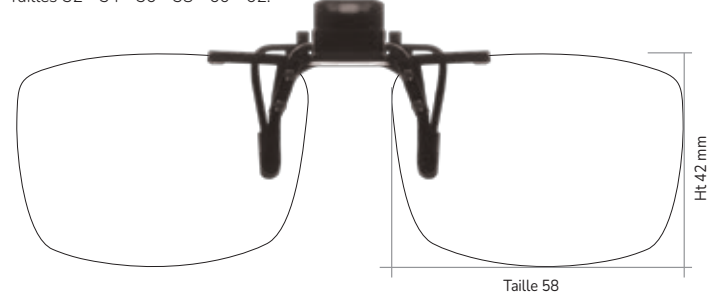

- TAILLE**
T. 52 Dimensions: L 52 mm - H 36 mm
T. 54 Dimensions: L 54 mm - H 38 mm
T. 56 Dimensions: L 56 mm - H 40 mm

- T. 58** Dimensions: L 58 mm - H 42 mm
T. 60 Dimensions: L 60 mm - H 44 mm
T. 62 Dimensions: L 62 mm - H 46 mm

RÉF. 133

Tailles 46 - 48 - 50 - 52 - 54 - 56.

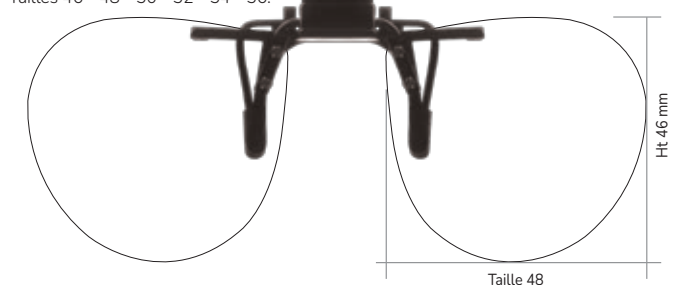

- TAILLE**
T. 46 Dimensions: L 46 mm - H 44 mm
T. 48 Dimensions: L 48 mm - H 46 mm
T. 50 Dimensions: L 50 mm - H 48 mm

- T. 52** Dimensions: L 52 mm - H 50 mm
T. 54 Dimensions: L 54 mm - H 52 mm
T. 56 Dimensions: L 56 mm - H 54 mm



Disponible dans tous les verres figurant ci-dessous

POLYCARBONATE

(épaisseur 2.00 mm taillable sur meule)

- | | | | | | | | | |
|-----------------|-----------------------|-----------------|-------------------|--------------------|---------------------|-------------------|--------------|--------------|
| BLANC CAT0
J | MIROIR INCOLORE
AI | JAUNE CAT0
V | MIROIR BLEU
AE | MIROIR JAUNE
AF | MIROIR ORANGE
AG | MIROIR ROSE
AH | MB CAT2
A | GB CAT2
B |
| MC CAT3
C | G15 CAT3
D | GC CAT3
E | MD CAT4
AP | GD CAT4
AQ | MIROIR CAT3
AR | | | |

ORGANIQUE

(épaisseur 1.80 mm taillable sur meule)

- | | | | | | | | | |
|-----------------|-------------------|---------------|---------------|-----------------|----------------------|--------------|---------------|--------------|
| MA CAT1
AC | ORANGE CAT2
AD | DEG CAT2
X | DEG CAT2
Z | ORDI. CAT2
O | ANTI-PHARE CAT1
W | MC CAT3
F | G15 CAT3
L | GC CAT3
M |
| BASE8 CAT3
K | MD CAT4
N | GD CAT4
P | | | | | | |

POLARISANT TAC

($\times 0.75$ mm découpable aux ciseaux)

- | | | | | | |
|-----------------|-------------------------|--------------|---------------|--------------|---------------|
| JAUNE CAT1
T | JAUNE FISHING CAT2
U | MC CAT3
Q | G15 CAT3
S | GC CAT3
R | GD CAT4
AT |
|-----------------|-------------------------|--------------|---------------|--------------|---------------|

BASSE VISION ORGANIQUE

(épaisseur 1.80 mm taillable sur meule).

- | | | | |
|------------------|------------------|------------------|------------------|
| 450 NM CAT1
G | 511 NM CAT1
H | 527 NM CAT1
I | 550 NM CAT2
Y |
|------------------|------------------|------------------|------------------|

BASSE VISION POLYCARBONATE

(épaisseur 2.00 mm taillable sur meule)

- | | | |
|-------------------|-------------------|-------------------|
| 450 NM CAT0
AU | 527 NM CAT1
AV | 550 NM CAT2
AW |
|-------------------|-------------------|-------------------|

POLYCARBONATE BLUE-BLOCKER (LUMIÈRE BLEUE)

- | |
|------------|
| CAT0
AZ |
|------------|



Réf. 606

MINICLIP

FACES RELEVABLES POLARISANTES

Avec étui souple. Verres au choix.
Possibilité de panacher dans les références.



Fabrication
Française



Systeme relevable
(Minimum 6 pièces)



Étui souple

Étui rigide



RÉF. 605

Tailles 52 - 54 - 56 - 58 - 60 - 62.

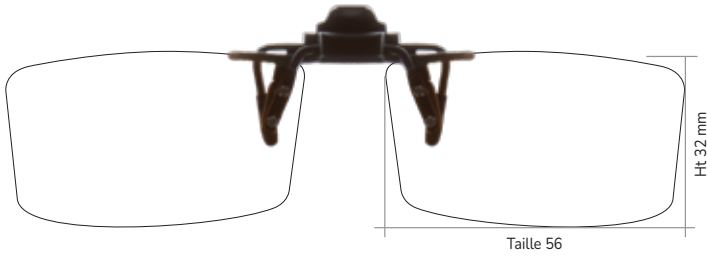

TAILLE

T. 52 Dimensions: L 52 mm - H 28 mm
T. 54 Dimensions: L 54 mm - H 30 mm
T. 56 Dimensions: L 56 mm - H 32 mm

T. 58 Dimensions: L 58 mm - H 34 mm
T. 60 Dimensions: L 60 mm - H 36 mm
T. 62 Dimensions: L 62 mm - H 38 mm

RÉF. 607

Tailles 52 - 54 - 56 - 58 - 60 - 62.

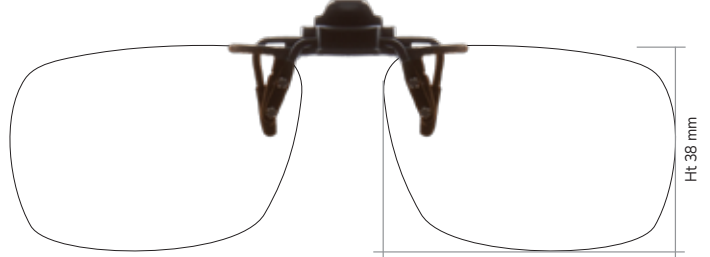

TAILLE

T. 52 Dimensions: L 52 mm - H 34 mm
T. 54 Dimensions: L 54 mm - H 36 mm
T. 56 Dimensions: L 56 mm - H 38 mm

T. 58 Dimensions: L 58 mm - H 40 mm
T. 60 Dimensions: L 60 mm - H 42 mm
T. 62 Dimensions: L 62 mm - H 44 mm

RÉF. 606

Tailles 52 - 54 - 56 - 58 - 60 - 62.

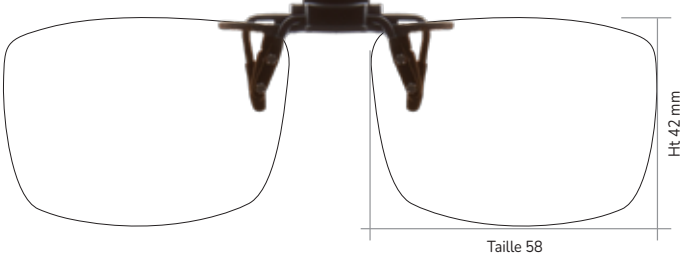

TAILLE

T. 52 Dimensions: L 52 mm - H 36 mm
T. 54 Dimensions: L 54 mm - H 38 mm
T. 56 Dimensions: L 56 mm - H 40 mm

T. 58 Dimensions: L 58 mm - H 42 mm
T. 60 Dimensions: L 60 mm - H 44 mm
T. 62 Dimensions: L 62 mm - H 46 mm

RÉF. 608

Tailles 52 - 54 - 56 - 58 - 60 - 62.

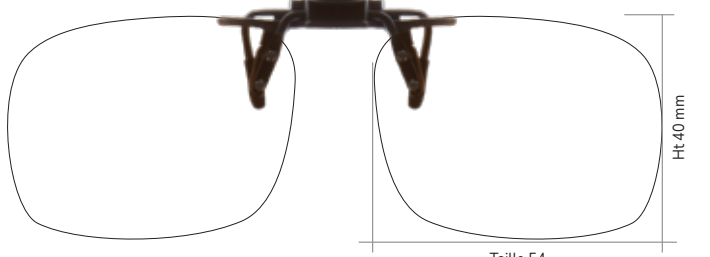

TAILLE

T. 52 Dimensions: L 52 mm - H 38 mm
T. 54 Dimensions: L 54 mm - H 40 mm
T. 56 Dimensions: L 56 mm - H 42 mm

T. 58 Dimensions: L 58 mm - H 44 mm
T. 60 Dimensions: L 60 mm - H 46 mm
T. 62 Dimensions: L 62 mm - H 48 mm

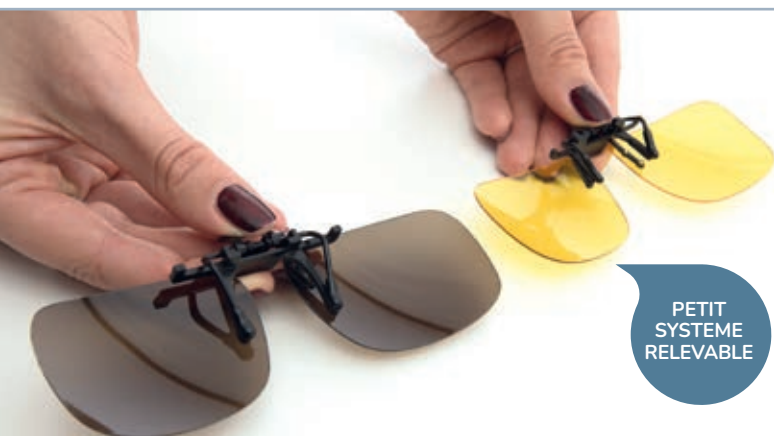

PETIT
SYSTEME
RELEVABLE

RÉF. 609

Tailles 50 - 52 - 54 - 56 - 58 - 60 - 62.

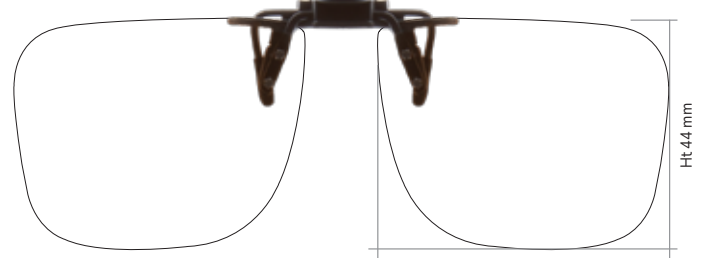

TAILLE

T. 50 Dimensions: L 50 mm - H 38 mm
T. 52 Dimensions: L 52 mm - H 40 mm
T. 54 Dimensions: L 54 mm - H 42 mm
T. 56 Dimensions: L 56 mm - H 44 mm

T. 58 Dimensions: L 58 mm - H 46 mm
T. 60 Dimensions: L 60 mm - H 48 mm
T. 62 Dimensions: L 62 mm - H 50 mm



RÉF. 610

Tailles 46 - 48 - 50 - 52 - 54 - 56.

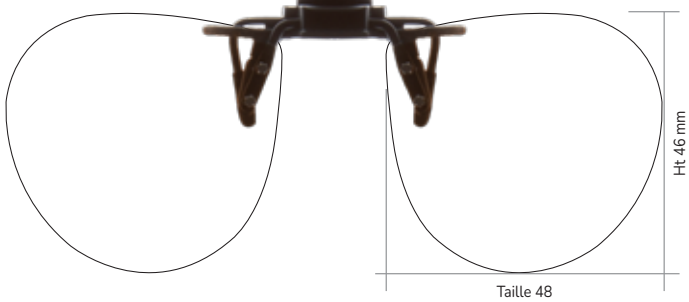

- T. 46 Dimensions: L 46 mm - H 44 mm
- T. 48 Dimensions: L 48 mm - H 46 mm
- T. 50 Dimensions: L 50 mm - H 48 mm

- T. 52 Dimensions: L 52 mm - H 50 mm
- T. 54 Dimensions: L 54 mm - H 52 mm
- T. 56 Dimensions: L 56 mm - H 54 mm

RÉF. 611

Tailles 51 - 53 - 55 - 57 - 59 - 61.

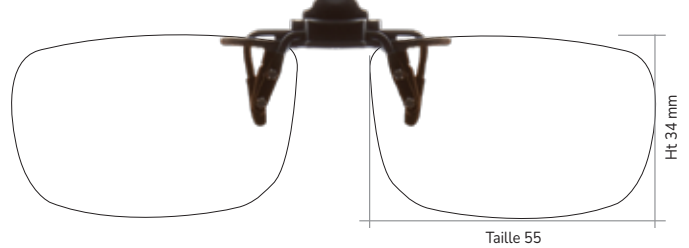

- TAILLE**
- T. 51 Dimensions: L 51 mm - H 30 mm
 - T. 53 Dimensions: L 53 mm - H 32 mm
 - T. 55 Dimensions: L 55 mm - H 34 mm

- T. 57 Dimensions: L 57 mm - H 36 mm
- T. 59 Dimensions: L 59 mm - H 38 mm
- T. 61 Dimensions: L 61 mm - H 40 mm

RÉF. 612

Tailles 55 - 57 - 60 - 62.

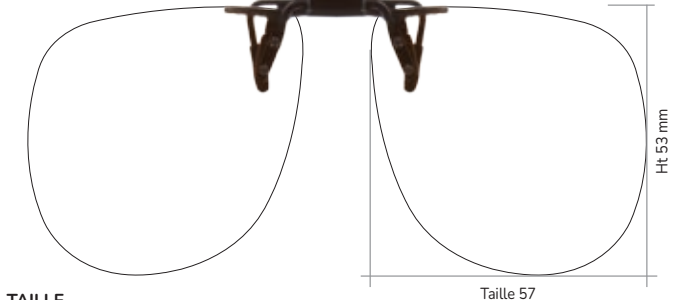

- TAILLE**
- T. 55 Dimensions: L 55 mm - H 51 mm
 - T. 57 Dimensions: L 57 mm - H 53 mm

- T. 60 Dimensions: L 60 mm - H 55 mm
- T. 62 Dimensions: L 62 mm - H 57 mm



Disponible dans tous les verres figurant ci-dessous

POLARISANT TAC

(<0.75 mm découplable aux ciseaux)



EASYCLIP

FACES RELEVABLES POLARISANTES

Avec étui souple. **Minimum 6 pièces au choix.**
Possibilité de panacher dans les références.



POLARISANT TAC

- MC
CAT3
- G15
CAT3
- G6
CAT3
- JAUNE
CAT1

Systeme relevable
(Minimum 6 pièces)



Étui souple

RÉF. 713Q

Polarisant brun cat. 3.

POLARISANT TAC

- MC
CAT3



RÉF. 715Q

Polarisant brun. cat. 3.

POLARISANT TAC

- MC
CAT3

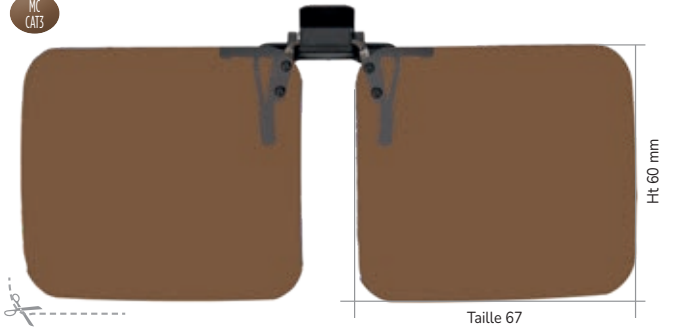

RÉF. 713S

Polarisant G15 cat. 3.

POLARISANT TAC

- G15
CAT3



RÉF. 715S

Polarisant G15 cat. 3.

POLARISANT TAC

- G15
CAT3



RÉF. 714S

Polarisant G15 cat. 3.

POLARISANT TAC

- G15
CAT3



RÉF. 716S

Polarisant G15 cat. 3.

POLARISANT TAC

- G15
CAT3

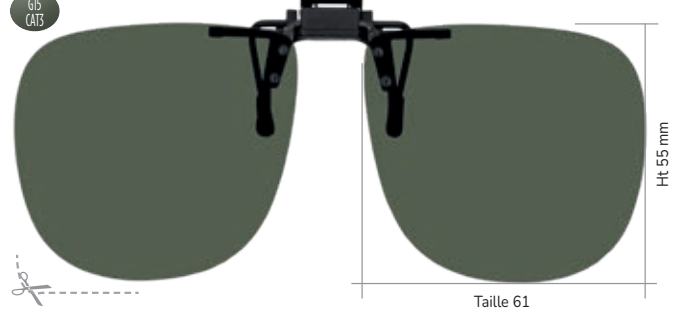

RÉF. 714Q

Polarisant brun cat. 3.

POLARISANT TAC

- MC
CAT3



RÉF. 716Q

Polarisant brun cat. 3.

POLARISANT TAC

- MC
CAT3



RÉF. 716T

Polarisant jaune cat. 1.

POLARISANT TAC

- JAUNE
CAT1



RÉF. 716R

Polarisant gris cat. 3.

POLARISANT TAC

- G6
CAT3



**SPÉCIAL
CONDUITE
DE NUIT,
SPORT**

confort pour
la conduite



BASSE VISION

450 nm, 511 nm, 527 nm, 550 nm



Avec étui rigide

LES FILTRES

Ils sont utilisés pour donner un meilleur confort visuel, accentuer les contrastes et réduire l'éblouissement. Pour cela ils filtrent les parties gênantes à ondes courtes et les U.V. de la lumière du jour.



Verre: 450 NM
CAT1
Code:

Bloque la lumière sous 450 nm.
Couleur: jaune.

Indications:

- Dégénérescence maculaire.
- Atrophie du nerf optique.



Verre: 511 NM
CAT1
Code: H

Bloque la lumière sous 511 nm.
Couleur: jaune-orangé.

Indications:

- Dégénérescence maculaire.
- Atrophie du nerf optique.
- Glaucome.
- Cataracte.
- Rétinite pigmentaire.



Verre: 527 NM
CAT1
Code:

Bloque la lumière sous 527 nm.
Couleur: rouge-orangé.

Indications:

- Glaucome.
- Cataracte.
- Rétinite pigmentaire.
- Rétinopathie diabétique.



Verre: 550 NM
CAT2
Code: Y

Bloque la lumière sous 550 nm.
Couleur: rouge.

Indications:

- Rétinite pigmentaire.

FASTCLIP RELEVABLES BASSE VISION

Montage vissé. Avec étui rigide.

115

Tailles 50 - 52 - 54 - 56 - 58 - 60.



450 nm

129

Tailles 52 - 54 - 56 - 58 - 60.



527 nm

116

Tailles 55 - 57 - 60.



511 nm

132

Tailles 52 - 54 - 56 - 58 - 60.



550 nm

VERRES AU CHOIX



DÉCOUVREZ TOUS LES MODÈLES de faces relevables pages 12

CLIP - ON REGLABLES BASSE VISION

Avec étui rigide.

121

Tailles 44 - 46 - 48 - 50 - 52 - 54 - 56.



511 nm

131

Tailles 52 - 54 - 56 - 58.

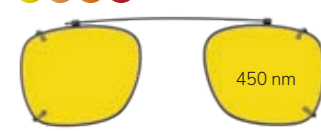

450 nm

VERRES AU CHOIX

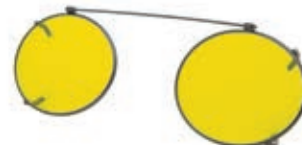

DÉCOUVREZ TOUS LES MODÈLES de clip-on réglables pages 10

LUNETTES BASSE VISION

Avec verres au choix. Avec étui rigide.

RÉF. 100

Monture métal noire, gun et marron. Branches flex. Taille 56-15.



450 nm

RÉF. 1014

Monture plastique noire. Branches métal. Taille 55-17.

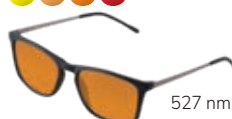

527 nm

DÉCOUVREZ TOUS LES MODÈLES de lunettes pages 18

RÉF. 69

Monture plastique noire. Taille 55-17.



550 nm

RÉF. 90

Monture plastique noire et ecaille. Taille 47-20.



511 nm

SURLUNETTES BASSE VISION

Avec verres au choix. Avec étui rigide.

RÉF. 315

Monture noire. Taille 55-22.



527 nm

RÉF. 316

Monture noire. Taille 61-18.



450 nm

RÉF. 326N

Monture noire. Taille 65-16.



550 nm

VERRES AU CHOIX



LUNETTES

Lunettes avec verres au choix.
Avec pochette tissu.



Réf. 90



Réf. 93



Choisissez vos verres



Pochette tissu

RÉF. 100

Monture métal noire, gun et marron.
Branches flex. Taille 56-15.



Verre Blue-blocker (AY):
réduit la fatigue de l'œil
sur tous types d'écrans.



Gun

Anti-lumière bleue



Marron

Antiphare

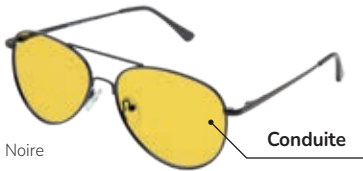

Noire

Conduite



RÉF. 69

Monture plastique noire.
Taille 55-17.



Anti-lumière bleue

RÉF. 84

Monture plastique noire.
Taille 49-20.



Antiphare



RÉF. 1014

Monture plastique noire.
Branches métal. Taille 55-17.



Antiphare



Verre Jaune Antiphare (W):
pour la conduite de nuit.
Atténue l'éblouissement
des phares.

RÉF. 90

Monture plastique noire et ecaille.
Taille 47-20.



Noire

Conduite



Ecaille

Anti-lumière bleue



RÉF. 91

Monture plastique marron.
Taille 47-18.



RÉF. 93

Monture plastique bleue ou grise.
Taille 48-20.



Bleue



Gris

RÉF. 96

Monture plastique noire.
Taille 50-16.



Antiphare

RÉF. 1024

Monture plastique noire.
Taille 56-18.

JAUNE
CATO



Conduite

Verre Jaune (AS):
pour la conduite, tir, ski.
Augmente le contraste
et la luminosité.

Disponible dans tous les verres figurant ci-dessous

POLYC.



AR

ORGANIQUE



AL



AC



AD



AS



X



Z



O



W



AM



AN



F



L



M



N



P

BASSE VISION ORGANIQUE



G



H



I



Y

ORGANIQUE BLUE-BLOCKER (LUMIÈRE BLEUE)



AY

LUNETTES DE PROTECTION



Pochette tissu



Norme EN 166

RÉF. 314B

Incolore.



RÉF. 314G

Gris cat. 3.



RÉF. 317

Lunettes de protection pour verres correcteurs.
Taille 57-16.



RÉF. 318

Lunettes de protection avec clip pour verres correcteurs.



CHAÎNETTES

RÉF. 225

Chaînettes fines métal gun.
Mini 6 pièces
(6 maillons différents).



RÉF. 227

Chaînettes métal
couleur boule fine.
Mini 6 pièces
(une de chaque couleur).

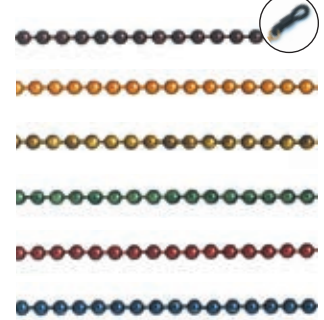

Marron
Jaune
Vert clair
Vert foncé
Rouge
Bleu

RÉF. 226

Chaînettes fines métal doré.
Mini 6 pièces
(6 maillons différents).



RÉF. 228

Chaînettes métal couleur.
Mini 6 pièces
(une de chaque couleur).

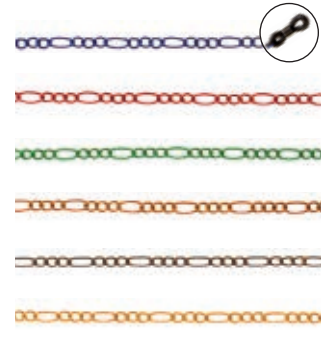

Bleu
Rouge
Vert
Ocre
Marron
Jaune

RÉF. 229

Chaînettes métal couleur
cylindre.
Mini 6 pièces
(une de chaque couleur).

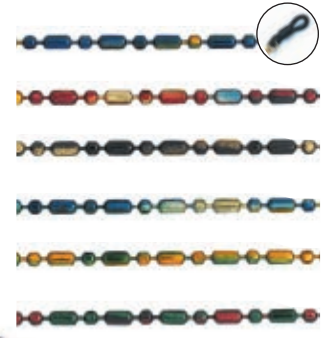

Bleu
Rouge
Vert
Rouille
Marron foncé
Marron clair

RÉF. 230

Chaînettes métal or et argent.
Mini 6 pièces
(trois de chaque couleur).



RÉF. 232

Chaînettes perles bois fantaisie.
Mini 6 pièces
(6 modèles différents).



RÉF. 158

Chaînettes perle grain de riz.
Mini 6 pièces.



Perle ivoire et argent

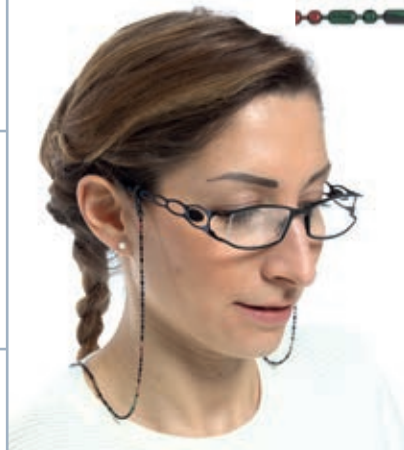

CORDONS

RÉF. 000

Cordon Polyamide Ø 2mm. Mini 12 pièces.



Noir

RÉF. 001

Cordon Polyamide Ø 2mm. Mini 12 pièces.



Marron

RÉF. 003

Cordon Polyamide Ø 2mm. Panaché de 6 couleurs. Mini 12 pièces (2 de chaque couleur).



Bleu



Bordeaux



Vert



Gris



Noir



Rouge

RÉF. 017

Cordon Satiné Ø 1.2mm. Mini 6 pièces coloris au choix.



Noir



Marron clair



Bordeaux

RÉF. 018

Cordon élastique Ø 3mm. Mini 12 pièces (6 noir, 6 marron).



Noir



Marron

RÉF. 010

Cordon Polyamide. Compact Ø 2mm. Caoutchouc Remplaçable. Mini 6 pièces coloris au choix.



Noir



Bleu Marine



Marron



Gris



Bordeaux

RÉF. 9119

Cordon coton ciré Ø 2mm. Mini 12 pièces (4 noir, 4 brun, 4 beige foncé).



Noir



Brun



Beige foncé

CORDONS JUNIOR

RÉF. 9135 ETOILE

Cordon élastique soft couleur Ø 2mm ajustable avec motif. Mini 12 pièces.



RÉF. 9136 POMME

Cordon élastique soft couleur Ø 2mm ajustable avec motif. Mini 12 pièces.



RÉF. 9072 ANIMAUX

Corde tressé polyamide couleur Ø 1.5mm ajustable avec motif. Mini 12 pièces.



RÉF. 9073 MICKEY

Corde tressé polyamide couleur Ø 1.5 mm ajustable avec motif. Mini 12 pièces.



RÉF. 9075 BALLON

Corde tressé polyamide couleur Ø 1.5mm ajustable avec motif. Mini 12 pièces.



CORDONS SPORT

RÉF. 704

Bandeau néoprène uni. Mini 12 pièces. Coloris au choix.

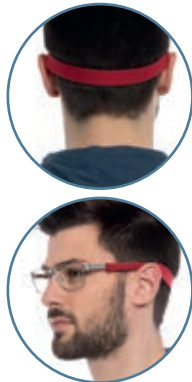
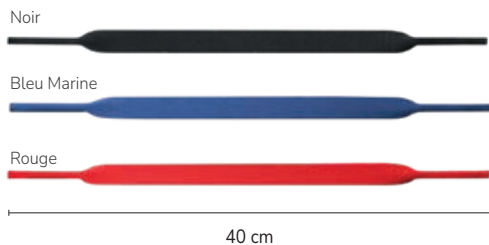

RÉF. 705

Cordon silicone. Mini 12 pièces. (2 de chaque couleur).



RÉF. 706

Cordons flotteurs. Mini 12 pièces. (4 bleu, 4 noir, 2 jaune fluo, 2 rose fluo).

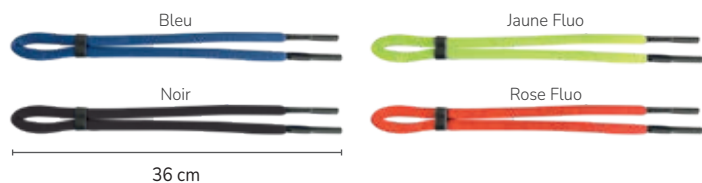

RÉF. 255

Chaussette lycra ajustable. Mini 12 pièces. (4 de chaque couleur).

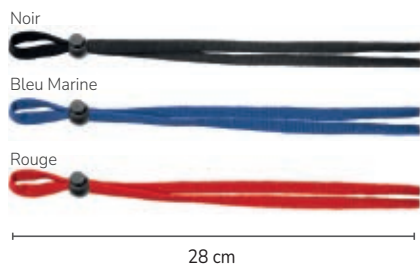

RÉF. 256

Mini 12 pièces. (4 de chaque couleur).



PRÉSENTOIR



OFFERT

LUNETTES MAQUILLAGE



Étui rigide

RÉF. 301

Monture plastique flex.
Verre basculant de droite à gauche.
Avec étui souple.
(+1.50/+2.00/+2.50/+3.00)



RÉF. 8904

Monture métal flex dorée.
Possibilité de changer les verres.
Avec étui souple.
(+1.50/+2.00/+2.50/+3.00/+3.50)



RÉF. 9121

Monture métal flex.
Possibilité de changer les verres.
Avec étui souple.
(+2.00/+2.50/+3.00/+3.50)

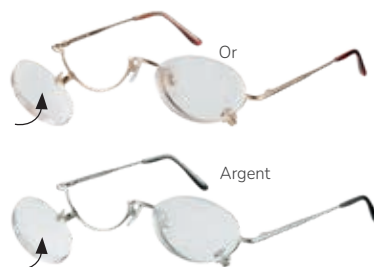

LUNETTES LOUPE

RÉF. 3305

50-20. Lunettes loupe face plastique. Branche métal plastique flex.
(+1,50/+2,00/+2,50/+3,00/+3,50/+4,00)

Ecaille



Noire

RÉF. RG04

50-20. Monture métal flex.
(+1,00/+1,50/+2,00/+2,50/+3,00/+3,50/+4,00)

Gun



Bleue

Marron



RÉF. 10127

50-15. Lunettes loupe métal branche plastique avec perle.
(+1,50/+2,00/+2,50/+3,00/+3,50)

Mauve



Argent

Noire



RÉF. 139

Face relevable correctrice. Avec étui souple.
(+1,50/+2,00/+2,50/+3,00)



Ht 50 mm

Taille 59



RÉF. 140

Face relevable correctrice. Avec étui souple.
(+1,50/+2,00/+2,50/+3,00)



Ht 31 mm

Taille 56



RÉF. 10196

50-15. Lunettes loupe métal nylon.
(+1,50/+2,00/+2,50/+3,00/+3,50)

Noire



Brun

Violet



RÉF. PR250

Protections latérales en cuir noir (paire).



RÉF. 10203

50-15. Lunettes loupe métal branche vitrail.
(+1,50/+2,00/+2,50/+3,00/+3,50)

Brun



Mauve

Bordeaux



