



FABRICANT
CLIPS SOLAIRES
DEPUIS 1947



CATALOGUE 2025

CLIPS SOLAIRES



CLIP - ON
RESSORT

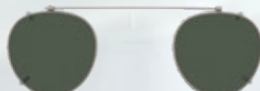

CLIP - ON
REGLABLES



FACES
RELEVABLES



CLIPS
UNIVERSELS

JHBUFFARD.COM

INDEX



SURLUNETTES
page 4



TINYCLIP
Clips universels polarisants
page 6



POLYCLIP
Clips universels polarisants
page 7



**CLIP - ON RESSORT
POLARISANTS**
page 8



CLIP - ON RESSORT
page 9



CLIP-ON RÉGLABLES
page 10



FASTCLIP
Faces relevables
page 12



MINICLIP
Faces relevables polarisantes
page 14



EASYCLIP
Faces relevables polarisantes
page 16



BASSE VISION
page 17



LUNETTES
page 18



**LUNETTES
DE PROTECTION**
page 19



CHAÎNETTES
page 20



CORDONS
page 21



CORDONS JUNIOR
page 21



CORDONS SPORT
page 22



LUNETTES MAQUILLAGE
page 22



LUNETTES LOUPE
page 23

BON DE COMMANDE
page 24



1

Pour vous inscrire sur notre site et acheter suivre les étapes suivantes : Inscrivez-vous dans l'onglet s'enregistrer en renseignant vos coordonnées, vous recevrez une confirmation sur votre messagerie.

S'ENREGISTRER

2

Dans la page d'accueil cliquez sur LOGIN et sur la fenêtre suivante tapez votre code utilisateur et mot de passe.

CONNEXION

3

Procéder à l'achat.



COMMENT COMMANDER PAR INTERNET

Votre commande sur www.jhbuffard.com



VERRES BASE 6

POLYCARBONATE



Verre: BLANC CAT0
Code: J



Verre: JAUNE CAT0
Code: V



Verre: MIROIR DÉGRADÉ
INCOLORE CAT0
Code: AI



Verre: MIROIR DÉGRADÉ
PASTEL BLEU CAT1
Code: AE



Verre: MIROIR DÉGRADÉ
PASTEL JAUNE CAT1
Code: AF



Verre: MIROIR DÉGRADÉ
PASTEL ORANGE CAT1
Code: AG



Verre: MIROIR DÉGRADÉ
PASTEL ROSE CAT1
Code: AH



Verre: MB CAT2
Code: A



Verre: GB CAT2
Code: B



Verre: MC CAT3
Code: C



Verre: G15 CAT3
Code: D



Verre: GC CAT3
Code: E



Verre: MD CAT4
Code: AP



Verre: GD CAT4
Code: AQ



Verre: MIROIR CAT3
Code: AR

Verre Jaune (V): pour la conduite, tir, ski.
Augmente le contraste et la luminosité.

ORGANIQUE



Verre: BLANC CAT0
Code: AL



Verre: MA CAT1
Code: AC



Verre: ORANGE CAT2
Code: AD



Verre: JAUNE CAT0
Code: AS



Verre: DEG CAT2
Code: X



Verre: DEG CAT2
Code: Z



Verre: ORDI. CAT2
Code: O



Verre: ANTI-PHARE CAT1
Code: W



Verre: MB CAT2
Code: AM



Verre: GB CAT2
Code: AN



Verre: MC CAT3
Code: F



Verre: G15 CAT3
Code: L



Verre: GC CAT3
Code: M



Verre: BASE8 CAT3
Code: K



Verre: MD CAT4
Code: N



Verre: GD CAT4
Code: P

Verre Jaune Antiphare (W): pour la conduite de nuit. Atténue l'éblouissement des phares.
Verre Ordinateur (O): pour écran ordinateur et télévision.
Verre Brun Cat. 1 (AC): usage d'intérieur.

POLARISANT TAC (TRICÉTATE)



Verre: JAUNE CAT1
Code: T



Verre: JAUNE FISHING
CAT2
Code: U



Verre: MC CAT3
Code: Q



Verre: G15 CAT3
Code: S



Verre: GC CAT3
Code: R



Verre: GD CAT4
Code: AT

Verre Jaune (T): pour la conduite, tir, ski. Atténue les reflets, augmente le contraste et la luminosité.
Verre Jaune Fishing (U): pour la pêche. Atténue les reflets.

ORGANIQUE BASSE VISION

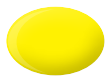

Verre: 450 NM CAT1
Code: G



Verre: 511 NM CAT1
Code: H



Verre: 527 NM CAT1
Code: I



Verre: 550 NM CAT2
Code: Y

POLYCARBONATE BASSE VISION



Verre: 450 NM CAT0
Code: AU



Verre: 527 NM CAT1
Code: AV



Verre: 550 NM CAT2
Code: AW

ORGANIQUE-POLARISANT



Verre: MC CAT3
Code: AA



Verre: G15 CAT3
Code: AB



Verre: GC CAT3
Code: AO



Verre: GD CAT4
Code: AX

BLUE-BLOCKER SPÉCIAL LUMIÈRE BLEUE



Verre: CAT0
organique
Code: AY



Verre: CAT0
polycarbonate
Code: AZ

* 6 paires minimum

CARACTÉRISTIQUES DES VERRES

Caractéristiques de nos faces relevables et types de verres:

- 1 Les faces relevables sont montées dans nos ateliers avec montage vissé (possibilité de changer de verre).
- 2 Choix de tailles et couleurs.
- 3 **Verre Organique:** épaisseur 1.80 mm taillable sur meule.

Verre Polycarbonate: épaisseur 2.00 mm taillable sur meule.

Verre Polarisant TAC: épaisseur 0.75 mm découppable aux ciseaux.

Verre Polarisant-Organique: épaisseur 2.00 mm taillable sur meule.

Categorie de filtre	Description	Domaine de transmission lumineuse		Usage recommandé
		De %	À %	
0	Teinte claire ou très légère	80	100	Pour des raisons cosmétiques ou pour utilisation sous une lumière faible/moyenne
1	Teinte légère	43	80	
2	Teinte sombre	18	43	
3	Teinte sombre	8	18	Pour une utilisation générale sous un soleil rayonnant et sous une lumière crue
4	Teinte très sombre	3	8	Ne convient pas à la conduite et à une utilisation sur route

SURLUNETTES

Surlunettes avec verres au choix.
Avec pochette tissu.
Esthétique, légère, confortable.

Réf. 316



Pochette
tissu



Choisissez
vos verres



LES LUNETTES
DE SOLEIL QUI FONT
SURLUNETTES



Étui rigide

RÉF. 322N

Monture noire.
Taille 61-14.



L 136

Ht 40 mm

RÉF. 323E

Monture écaille.
Taille 61-13.



L 135

Ht 42 mm

RÉF. 322E

Monture écaille.
Taille 61-14.



RÉF. 323N

Monture noire.
Taille 61-13.



RÉF. 324E

Monture écaille.
Taille 60-14.



L 134

Ht 39 mm

RÉF. 325N

Monture noire.
Taille 62-14.



L 138

Ht 43 mm

RÉF. 324N

Monture noire.
Taille 60-14.



RÉF. 325E

Monture écaille.
Taille 62-14.



RÉF. 326E

Monture écaille.
Taille 65-16.



L 146



RÉF. 326N

Monture noire.
Taille 65-16.



RÉF. 327N

Monture noire.
Taille 66-20.



L 147



RÉF. 327E

Monture écaille.
Taille 66-20.



RÉF. 315

Monture noire.
Taille 55-22.



L 132



RÉF. 316

Monture noire.
Taille 61-18.



L 139



OFFERT PRÉSENTOIR

Présentoir aide à la vente.
Offert pour une commande de 12 pièces.

Disponible dans tous les verres figurant ci-dessous
POLYCARBONATE

MIROIR
CAT3

AR

ORGANIQUE



ORGANIQUE-POLARISANT



BASSE VISION ORGANIQUE



ORGANIQUE BLUE-BLOCKER (LUMIÈRE BLEUE)

CATO
AY

**VERRES
AU CHOIX**



TINYCLIP

CLIPS UNIVERSELS POLARISANTS

Clip universel polarisant à griffe nasale prenant sur le pont de la monture. Avec étui rigide. A retoucher avec des ciseaux (si nécessaire). Simple et rapide.



≈ 0.75 mm
découpable
aux ciseaux

Avec étui rigide



Système nez métallique avec crochets recouverts de gaine plastique antidérapante

Crochets avec gaine antidérapante

RÉF. 260 - 263 - 265 - 266

Votre Clip déjà monté en verres polarisants cat. 3. Pour montures métal.

Quatre formes disponibles:

POLARISANT TAC



RÉF. 260Q

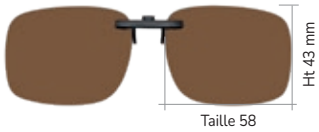

RÉF. 260S



RÉF. 263Q

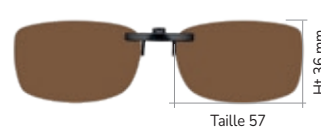

RÉF. 263S



RÉF. 265Q

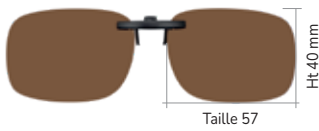

RÉF. 265S



RÉF. 266Q

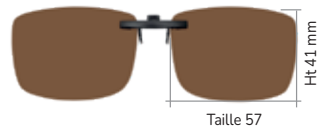

RÉF. 266S

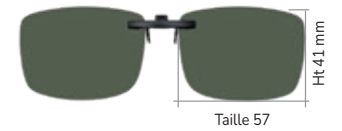



POLYCLIP

CLIPS UNIVERSELS POLARISANTS

Clip universel polarisant à griffe nasale prenant sur le verre. Avec étui rigide.
A retoucher avec des ciseaux (si nécessaire).
Simple et rapide.



∞ 0.75 mm
découpable
aux ciseaux

Avec étui rigide



Système nez
métallique avec
crochets recouverts
de gaine plastique
antidérapante

Crochets
avec gaine
antidérapante

RÉF. 160 - 162 - 163 - 164 - 165 166 - 167 - 168 - 169 - 170

Votre Clip déjà monté en verres polarisants Cat. 3 et jaune Cat. 1. Pour monture métal et plastique.

Dix formes disponibles:

POLARISANT TAC



RÉF. 160Q

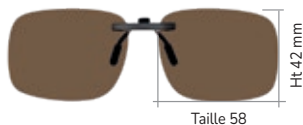

RÉF. 160R



RÉF. 160S

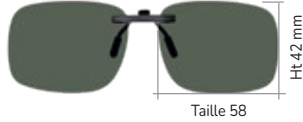

RÉF. 160T

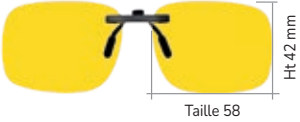

RÉF. 162Q

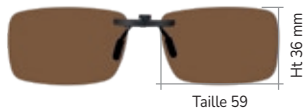

RÉF. 162R



RÉF. 163Q

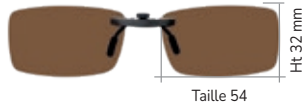

RÉF. 163R



RÉF. 164Q

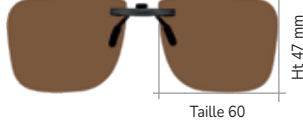

RÉF. 164S

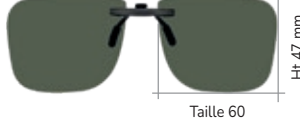

RÉF. 165Q

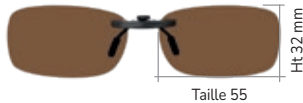

RÉF. 165R



RÉF. 166Q Tailles 55

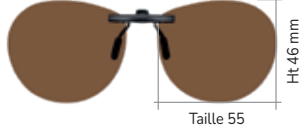

RÉF. 166Q Tailles 57

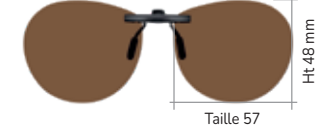

RÉF. 166S Tailles 55



RÉF. 166S Tailles 57



RÉF. 166R Tailles 55



RÉF. 166R Tailles 57



RÉF. 166T Tailles 57

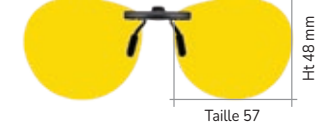

TAILLE

T. 55 Dimensions: L 55 mm - H 46 mm

T. 57 Dimensions: L 57 mm - H 48 mm

RÉF. 167Q

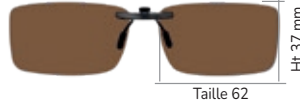

RÉF. 167R



RÉF. 168Q

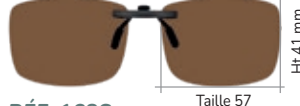

RÉF. 168R

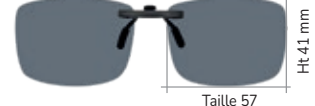

RÉF. 168S



RÉF. 169Q

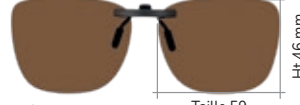

RÉF. 169R

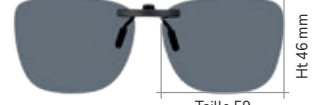

RÉF. 169S



RÉF. 170Q

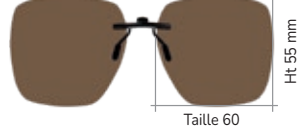

RÉF. 170S

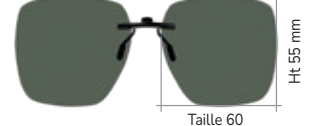

CLIP - ON RESSORT POLARISANTS

Avec étui souple. **Minimum 6 pièces au choix.**
Possibilité de panacher dans les références.



Réf. 453G



Ressort discret



Étui souple



RÉF. 420G

Gun - G15 Cat. 3.
Tailles 48 - 50 - 52.

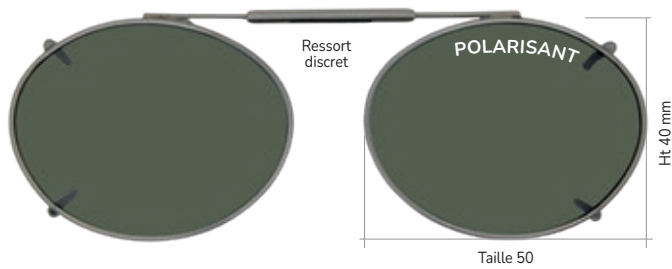

RÉF. 420N
Noir - MC Cat. 3.
Tailles 48 - 50 - 52.

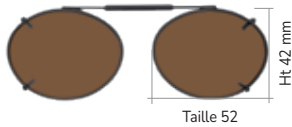

TAILLE
T. 48 Dimensions: L 48 mm - H 38 mm
T. 50 Dimensions: L 50 mm - H 40 mm
T. 52 Dimensions: L 52 mm - H 42 mm

RÉF. 432N

Noir - MC Cat. 3.
Tailles 53 - 55 - 57.

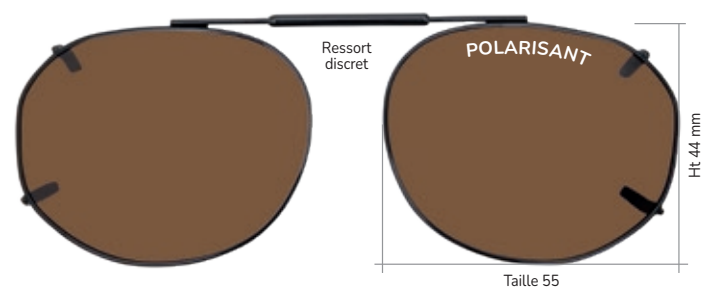

RÉF. 432G
Gun - G15 Cat. 3.
Tailles 53 - 55 - 57.

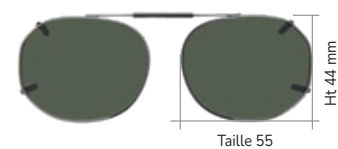

TAILLE
T. 53 Dimensions: L 53 mm - H 42 mm
T. 55 Dimensions: L 55 mm - H 44 mm
T. 57 Dimensions: L 57 mm - H 46 mm

RÉF. 442G

Gun - G15 Cat. 3.
Tailles 50 - 53 - 55.

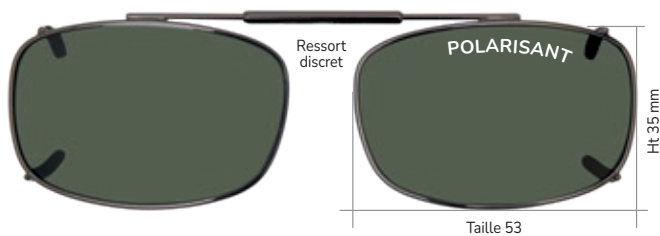

RÉF. 442N
Noir - MC Cat. 3.
Tailles 50 - 53 - 55.

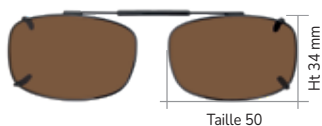

TAILLE
T. 50 Dimensions: L 50 mm - H 34 mm
T. 53 Dimensions: L 53 mm - H 35 mm
T. 55 Dimensions: L 55 mm - H 36 mm

RÉF. 454N

Noir - MC Cat. 3.
Tailles 48 - 50 - 52.

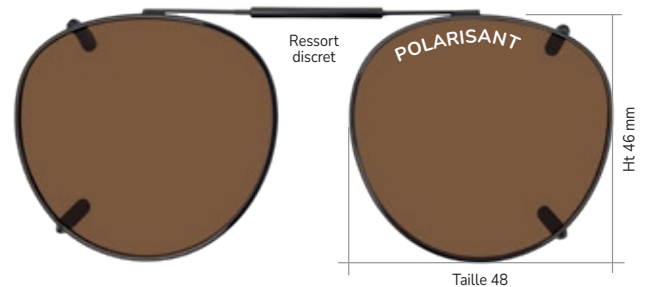

RÉF. 454G
Gun - G15 Cat. 3.
Tailles 48 - 50 - 52.

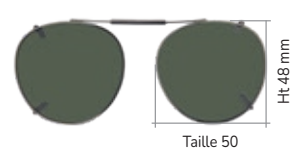

TAILLE
T. 48 Dimensions: L 48 mm - H 46 mm
T. 50 Dimensions: L 50 mm - H 48 mm
T. 52 Dimensions: L 52 mm - H 50 mm

CLIP - ON RESSORT

Gun / G15 et Noir / MC Cat. 3. Avec étui souple. **Minimum 6 pièces au choix.**
Possibilité de panacher dans les références.



Étui souple

RÉF. 419G

Gun - G15 Cat. 3.
Tailles 48.

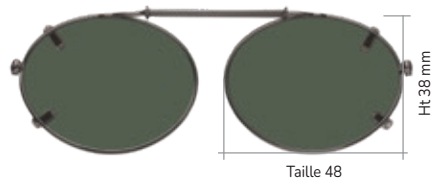

TAILLE

T. 48 Dimensions: L 48 mm - H 38 mm

RÉF. 452G

Gun - Gris Cat. 3.
Tailles 54 - 58 - 60.

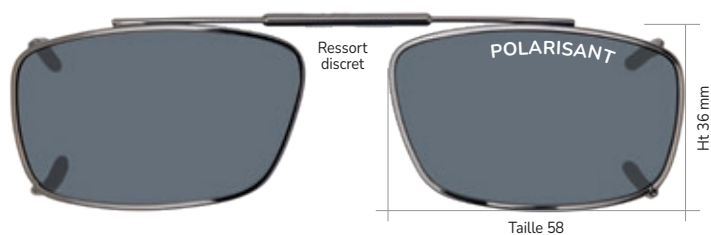

RÉF. 452N

Noir - MC Cat. 3.
Tailles 54 - 58 - 60.

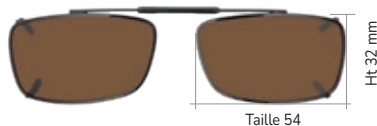

TAILLE

T. 54 Dimensions: L 54 mm - H 32 mm
T. 58 Dimensions: L 58 mm - H 36 mm
T. 60 Dimensions: L 60 mm - H 38 mm

RÉF. 431N

Noir - MC Cat. 3.
Tailles 53.

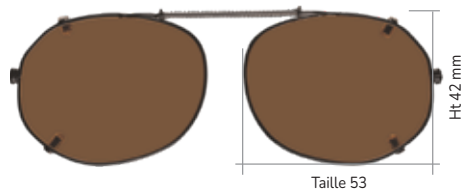

TAILLE

T. 53 Dimensions: L 53 mm - H 42 mm

RÉF. 441G

Gun - G15 Cat. 3.
Tailles 48.

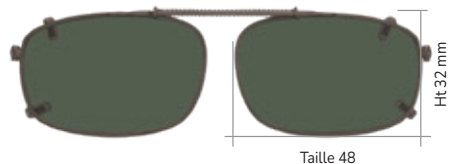

RÉF. 441N

Noir - MC Cat. 3.
Tailles 48 - 50.

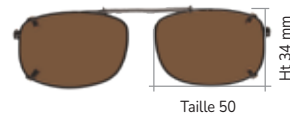

TAILLE

T. 48 Dimensions: L 48 mm - H 32 mm
T. 50 Dimensions: L 50 mm - H 34 mm

RÉF. 453G

Gun - Gris Cat. 3.
Tailles 54 - 57.

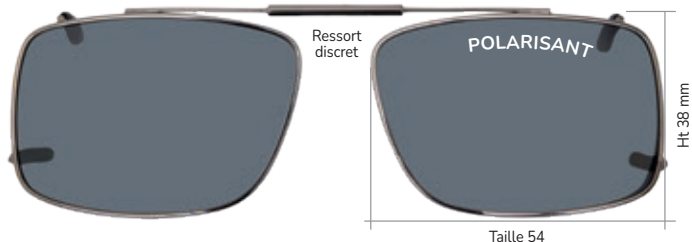

RÉF. 453N

Noir - MC Cat. 3.
Tailles 54 - 57.

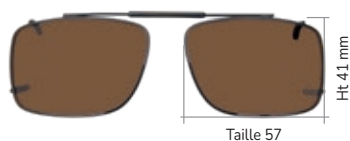

TAILLE

T. 54 Dimensions: L 54 mm - H 38 mm
T. 57 Dimensions: L 57 mm - H 41 mm

RÉF. 461G

Gun - G15 Cat. 3.
Tailles 55 - 58.



RÉF. 461N

Noir - MC Cat. 3.
Tailles 55 - 58.

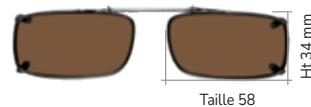

TAILLE

T. 55 Dimensions: L 55 mm - H 31 mm
T. 58 Dimensions: L 58 mm - H 34 mm

CLIP - ON REGLABLES

En doré, noir ou ruthénium. Avec étui souple.
Possibilité de panacher dans les références.



Fabrication
Française



Étui souple



Étui rigide
transparent



Réf. 121



Réglable



Choisissez
vos verres



RÉF 119N

Ovale. Monture métal noir. Tailles 42 - 44 - 46 - 48 - 50 - 52 - 54.

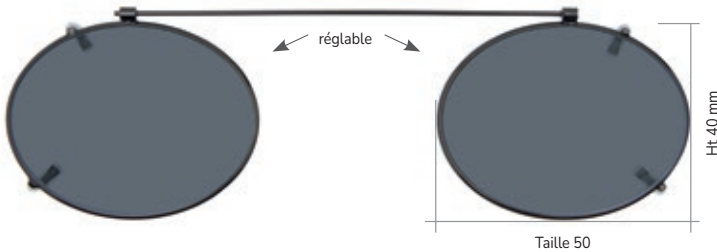

RÉF 119R

Monture métal ruthénium.



RÉF 119D

Monture métal doré.



TAILLE

T. 42 Dimensions: L 42 mm - H 32 mm
T. 44 Dimensions: L 44 mm - H 34 mm
T. 46 Dimensions: L 46 mm - H 36 mm
T. 48 Dimensions: L 48 mm - H 38 mm

T. 50 Dimensions: L 50 mm - H 40 mm
T. 52 Dimensions: L 52 mm - H 42 mm
T. 54 Dimensions: L 54 mm - H 44 mm

RÉF 121R

Pantos. Monture métal ruthénium. Tailles 44 - 46 - 48 - 50 - 52 - 54 - 56.

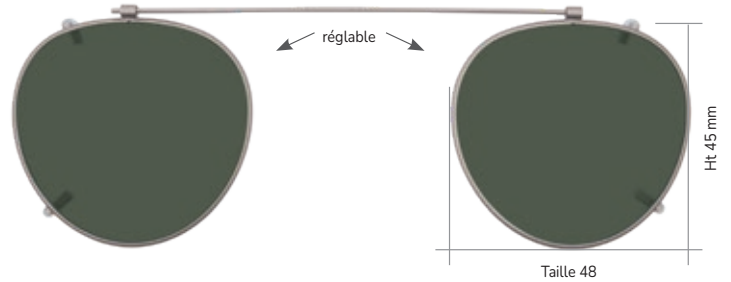

RÉF 121D

Monture métal doré.



RÉF 121N

Monture métal noir.



TAILLE

T. 44 Dimensions: L 44 mm - H 41 mm
T. 46 Dimensions: L 46 mm - H 43 mm
T. 48 Dimensions: L 48 mm - H 45 mm
T. 50 Dimensions: L 50 mm - H 47 mm

T. 52 Dimensions: L 52 mm - H 49 mm
T. 54 Dimensions: L 54 mm - H 51 mm
T. 56 Dimensions: L 56 mm - H 53 mm

RÉF 120D

Rond. Monture métal doré. Tailles 40 - 42 - 44 - 46 - 48 - 50 - 52.

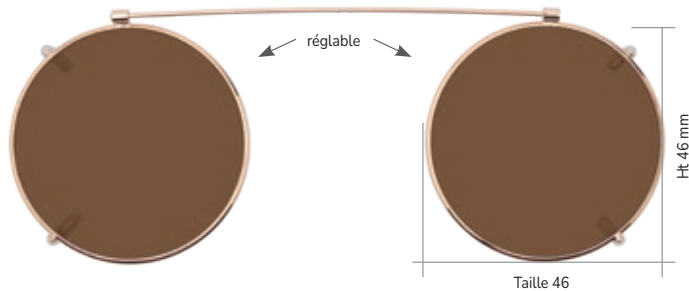

RÉF 120N

Monture métal noir.



RÉF 120R

Monture métal ruthénium.



TAILLE

T. 40 Dimensions: L 40 mm - H 40 mm
T. 42 Dimensions: L 42 mm - H 42 mm
T. 44 Dimensions: L 44 mm - H 44 mm
T. 46 Dimensions: L 46 mm - H 46 mm

T. 48 Dimensions: L 48 mm - H 48 mm
T. 50 Dimensions: L 50 mm - H 50 mm
T. 52 Dimensions: L 52 mm - H 52 mm

RÉF 131N

Carré. Monture métal noir. Tailles 52 - 54 - 56 - 58.

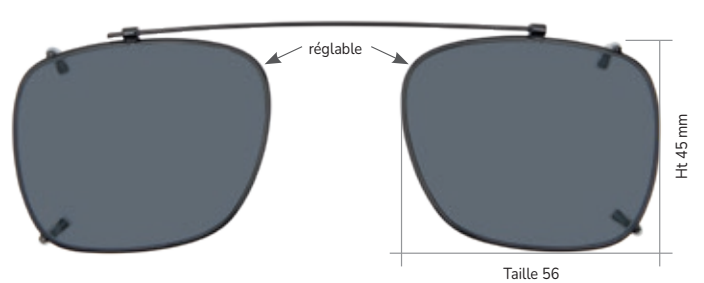

RÉF 131R

Monture métal ruthénium.



RÉF 131D

Monture métal doré.



TAILLE

T. 52 Dimensions: L 52 mm - H 41 mm
T. 54 Dimensions: L 54 mm - H 43 mm

T. 56 Dimensions: L 56 mm - H 45 mm
T. 58 Dimensions: L 58 mm - H 47 mm

RÉF 141N

Rectangle. Monture métal noir. Tailles 46 - 48 - 50 - 52 - 54 - 56 - 58.

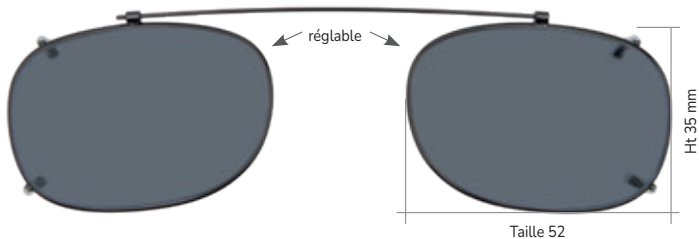

RÉF 141R

Monture métal ruthénium.



RÉF 141D

Monture métal doré.



TAILLE

T. 46 Dimensions: L 46 mm - H 29 mm
 T. 48 Dimensions: L 48 mm - H 31 mm
 T. 50 Dimensions: L 50 mm - H 33 mm
 T. 52 Dimensions: L 52 mm - H 35 mm

T. 54 Dimensions: L 54 mm - H 37 mm
 T. 56 Dimensions: L 56 mm - H 39 mm
 T. 58 Dimensions: L 58 mm - H 41 mm

RÉF 171D

Rectangle. Monture métal doré. Taille 58.

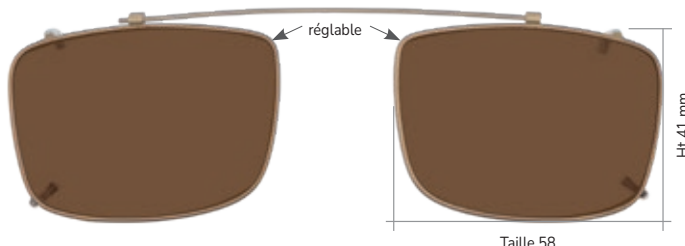

RÉF 171N

Monture métal noir.



RÉF 171R

Monture métal ruthénium.



TAILLE

T. 58 Dimensions: L 58 mm - H 41 mm

RÉF 151D

Tonneau. Monture métal doré. Tailles 50 - 52 - 54 - 56.

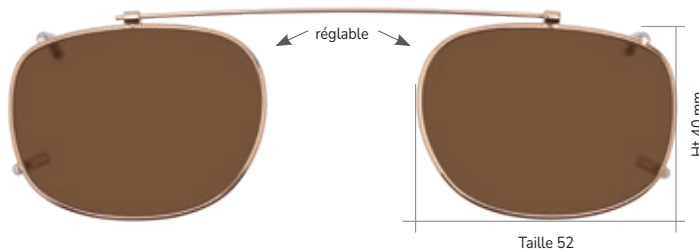

RÉF 151N

Monture métal noir.



RÉF 151R

Monture métal ruthénium.



TAILLE

T. 50 Dimensions: L 50 mm - H 38 mm
 T. 52 Dimensions: L 52 mm - H 40 mm

T. 54 Dimensions: L 54 mm - H 42 mm
 T. 56 Dimensions: L 56 mm - H 44 mm

RÉF 161R

Rectangle. Monture métal ruthénium. Tailles 52 - 54 - 56 - 58.

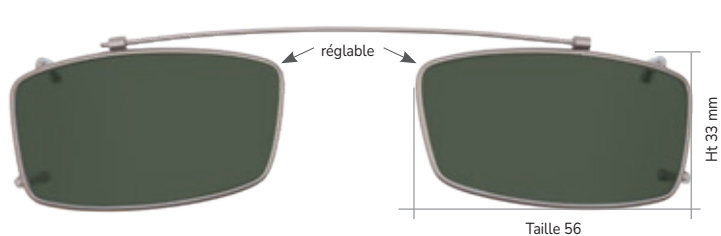

RÉF 161D

Monture métal doré.



RÉF 161N

Monture métal noir.



TAILLE

T. 52 Dimensions: L 52 mm - H 29 mm
 T. 54 Dimensions: L 54 mm - H 31 mm

T. 56 Dimensions: L 56 mm - H 33 mm
 T. 58 Dimensions: L 58 mm - H 35 mm



Disponible dans tous les verres figurant ci-dessous

POLYCARBONATE



AR

ORGANIQUE



BASSE VISION ORGANIQUE



ORGANIQUE BLUE-BLOCKER (LUMIÈRE BLEUE)



FASTCLIP

FACES RELEVABLES

Montage vissé. Avec étui souple.
Verres au choix. Possibilité de panacher
dans les références.



Fabrication
Française



Système relevable
(Minimum 6 pièces)



Étui souple



Étui rigide

CHOISISSEZ
VOS
VERRES



RÉF. 115

Tailles 50 - 52 - 54 - 56 - 58 - 60 - 62.

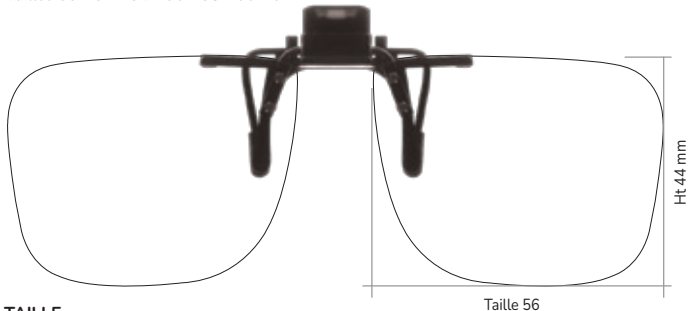

TAILLE

T. 50 Dimensions: L 50 mm - H 38 mm
T. 52 Dimensions: L 52 mm - H 40 mm
T. 54 Dimensions: L 54 mm - H 42 mm
T. 56 Dimensions: L 56 mm - H 44 mm

T. 58 Dimensions: L 58 mm - H 46 mm
T. 60 Dimensions: L 60 mm - H 48 mm
T. 62 Dimensions: L 62 mm - H 50 mm

RÉF. 118

Tailles 50 - 52 - 54 - 56 - 58 - 60 - 62.

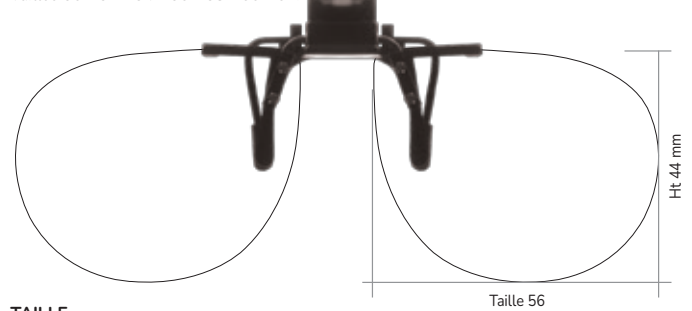

TAILLE

T. 50 Dimensions: L 50 mm - H 37 mm
T. 52 Dimensions: L 52 mm - H 39 mm
T. 54 Dimensions: L 54 mm - H 41 mm
T. 56 Dimensions: L 56 mm - H 44 mm

T. 58 Dimensions: L 58 mm - H 46 mm
T. 60 Dimensions: L 60 mm - H 48 mm
T. 62 Dimensions: L 62 mm - H 50 mm

RÉF. 116

Tailles 55 - 57 - 60.

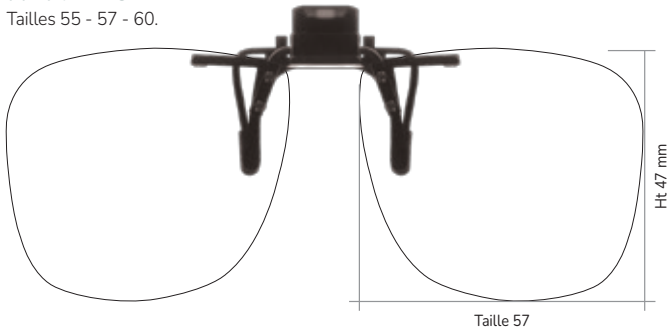

TAILLE

T. 55 Dimensions: L 55 mm - H 45 mm
T. 57 Dimensions: L 57 mm - H 47 mm

T. 60 Dimensions: L 60 mm - H 50 mm
T. 62 Dimensions: L 62 mm - H 52 mm

RÉF. 125

Tailles 52 - 54 - 56 - 58 - 60 - 62.

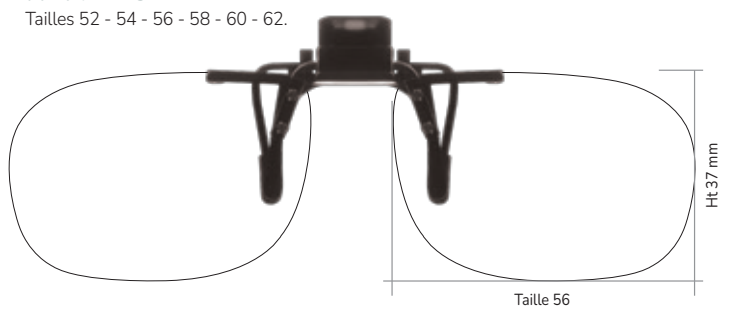

TAILLE

T. 52 Dimensions: L 52 mm - H 33 mm
T. 54 Dimensions: L 54 mm - H 35 mm
T. 56 Dimensions: L 56 mm - H 37 mm

T. 58 Dimensions: L 58 mm - H 39 mm
T. 60 Dimensions: L 60 mm - H 41 mm
T. 62 Dimensions: L 62 mm - H 43 mm

RÉF. 127

Tailles 52 - 54 - 56 - 58 - 60 - 62.

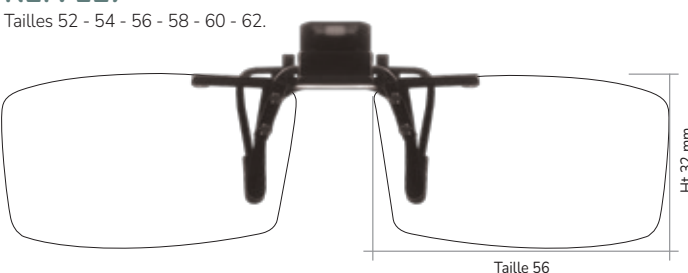

TAILLE

T. 52 Dimensions: L 52 mm - H 28 mm
T. 54 Dimensions: L 54 mm - H 30 mm
T. 56 Dimensions: L 56 mm - H 32 mm

T. 58 Dimensions: L 58 mm - H 34 mm
T. 60 Dimensions: L 60 mm - H 36 mm
T. 62 Dimensions: L 62 mm - H 38 mm

RÉF. 128

Tailles 51 - 53 - 55 - 57 - 59 - 61.

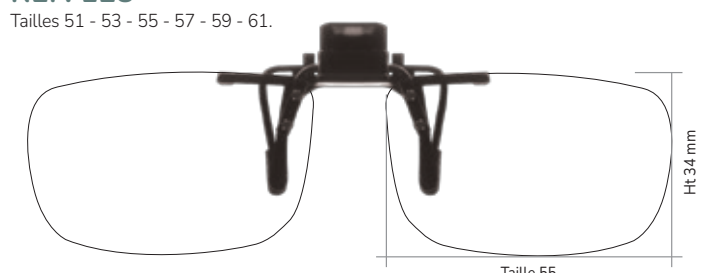

TAILLE

T. 51 Dimensions: L 51 mm - H 30 mm
T. 53 Dimensions: L 53 mm - H 32 mm
T. 55 Dimensions: L 55 mm - H 34 mm

T. 57 Dimensions: L 57 mm - H 36 mm
T. 59 Dimensions: L 59 mm - H 38 mm
T. 61 Dimensions: L 61 mm - H 40 mm



Réf. 115



RÉF. 129

Tailles 52 - 54 - 56 - 58 - 60 - 62.

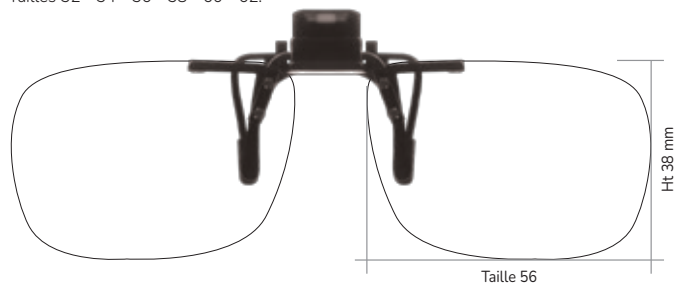

TAILLE

- T. 52 Dimensions: L 52 mm - H 34 mm
- T. 54 Dimensions: L 54 mm - H 36 mm
- T. 56 Dimensions: L 56 mm - H 38 mm

- T. 58 Dimensions: L 58 mm - H 40 mm
- T. 60 Dimensions: L 60 mm - H 42 mm
- T. 62 Dimensions: L 62 mm - H 44 mm

RÉF. 132

Tailles 52 - 54 - 56 - 58 - 60 - 62.

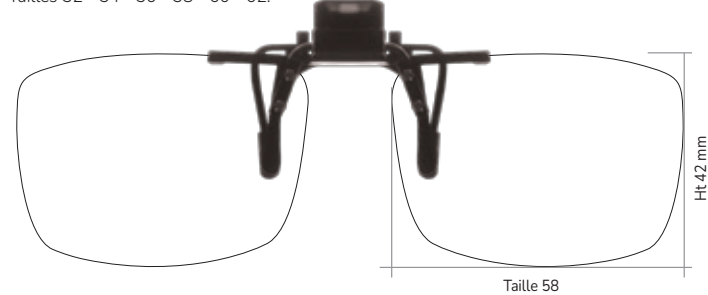

TAILLE

- T. 52 Dimensions: L 52 mm - H 36 mm
- T. 54 Dimensions: L 54 mm - H 38 mm
- T. 56 Dimensions: L 56 mm - H 40 mm

- T. 58 Dimensions: L 58 mm - H 42 mm
- T. 60 Dimensions: L 60 mm - H 44 mm
- T. 62 Dimensions: L 62 mm - H 46 mm

RÉF. 133

Tailles 46 - 48 - 50 - 52 - 54 - 56.

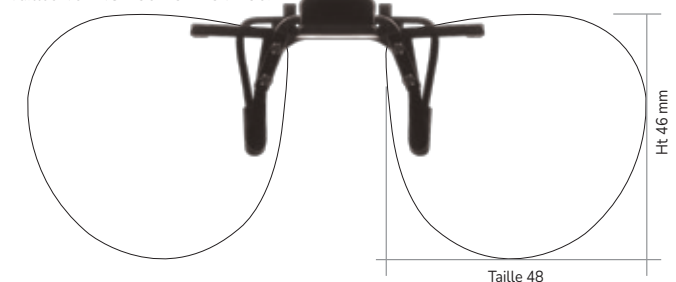

TAILLE

- T. 46 Dimensions: L 46 mm - H 44 mm
- T. 48 Dimensions: L 48 mm - H 46 mm
- T. 50 Dimensions: L 50 mm - H 48 mm

- T. 52 Dimensions: L 52 mm - H 50 mm
- T. 54 Dimensions: L 54 mm - H 52 mm
- T. 56 Dimensions: L 56 mm - H 54 mm



Disponible dans tous les verres figurant ci-dessous

POLYCARBONATE

(épaisseur 2.00 mm taillable sur meule)

- | | | | | | | | | |
|-----------------|-----------------------|-----------------|-------------------|--------------------|---------------------|-------------------|--------------|--------------|
| BLANC CAT0
J | MIROIR INCOLORE
AI | JAUNE CAT0
V | MIROIR BLEU
AE | MIROIR JAUNE
AF | MIROIR ORANGE
AG | MIROIR ROSE
AH | MB CAT2
A | GB CAT2
B |
| MC CAT3
C | G15 CAT3
D | GC CAT3
E | MD CAT4
AP | GD CAT4
AQ | MIROIR CAT3
AR | | | |

ORGANIQUE

(épaisseur 1.80 mm taillable sur meule)

- | | | | | | | | | |
|-----------------|-------------------|---------------|---------------|-----------------|----------------------|--------------|---------------|--------------|
| MA CAT1
AC | ORANGE CAT2
AD | DEG CAT2
X | DEG CAT2
Z | ORDI. CAT2
O | ANTI-PHARE CAT1
W | MC CAT3
F | G15 CAT3
L | GC CAT3
M |
| BASE8 CAT3
K | MD CAT4
N | GD CAT4
P | | | | | | |

POLARISANT TAC

(x0.75 mm découpable aux ciseaux)

- | | | | | | |
|-----------------|-------------------------|--------------|---------------|--------------|---------------|
| JAUNE CAT1
T | JAUNE FISHING CAT2
U | MC CAT3
Q | G15 CAT3
S | GC CAT3
R | GD CAT4
AT |
|-----------------|-------------------------|--------------|---------------|--------------|---------------|

BASSE VISION ORGANIQUE

(épaisseur 1.80 mm taillable sur meule)

- | | | | |
|------------------|------------------|------------------|------------------|
| 450 NM CAT1
G | 511 NM CAT1
H | 527 NM CAT1
I | 550 NM CAT2
Y |
|------------------|------------------|------------------|------------------|

BASSE VISION POLYCARBONATE

(épaisseur 2.00 mm taillable sur meule)

- | | | |
|-------------------|-------------------|-------------------|
| 450 NM CAT0
AU | 527 NM CAT1
AV | 550 NM CAT2
AW |
|-------------------|-------------------|-------------------|

POLYCARBONATE BLUE-BLOCKER (LUMIÈRE BLEUE)

- | |
|------------|
| CAT0
AZ |
|------------|

MINICLIP

FACES RELEVABLES POLARISANTES

Avec étui souple. Verres au choix.
Possibilité de panacher dans les références.

Réf. 606



Fabrication
Française



Systeme relevable
(Minimum 6 pièces)



Étui souple



Étui rigide

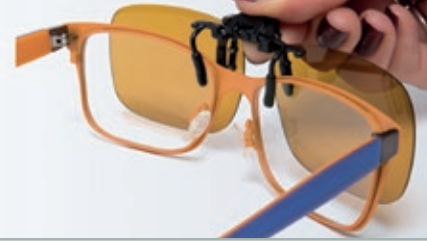

RÉF. 605

Tailles 52 - 54 - 56 - 58 - 60 - 62.

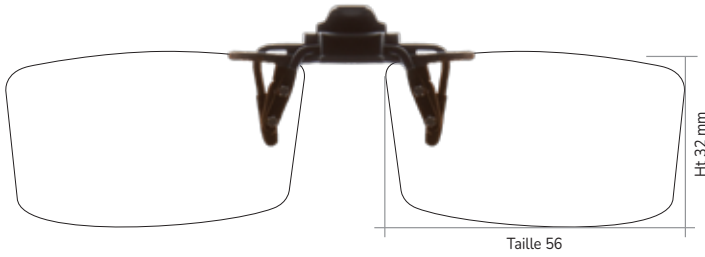

TAILLE

T. 52 Dimensions: L 52 mm - H 28 mm
T. 54 Dimensions: L 54 mm - H 30 mm
T. 56 Dimensions: L 56 mm - H 32 mm

T. 58 Dimensions: L 58 mm - H 34 mm
T. 60 Dimensions: L 60 mm - H 36 mm
T. 62 Dimensions: L 62 mm - H 38 mm

RÉF. 607

Tailles 52 - 54 - 56 - 58 - 60 - 62.

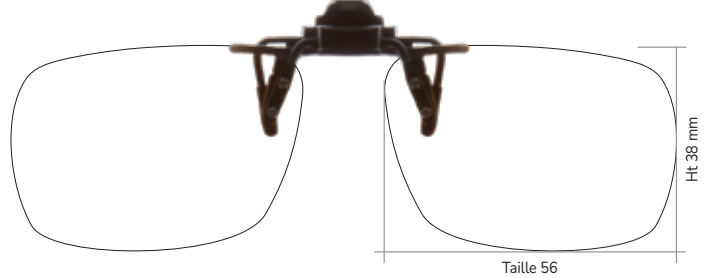

TAILLE

T. 52 Dimensions: L 52 mm - H 34 mm
T. 54 Dimensions: L 54 mm - H 36 mm
T. 56 Dimensions: L 56 mm - H 38 mm

T. 58 Dimensions: L 58 mm - H 40 mm
T. 60 Dimensions: L 60 mm - H 42 mm
T. 62 Dimensions: L 62 mm - H 44 mm

RÉF. 606

Tailles 52 - 54 - 56 - 58 - 60 - 62.

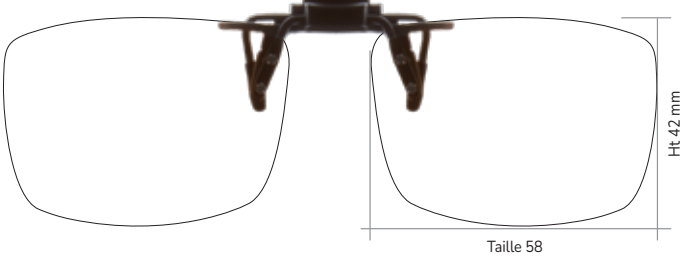

TAILLE

T. 52 Dimensions: L 52 mm - H 36 mm
T. 54 Dimensions: L 54 mm - H 38 mm
T. 56 Dimensions: L 56 mm - H 40 mm

T. 58 Dimensions: L 58 mm - H 42 mm
T. 60 Dimensions: L 60 mm - H 44 mm
T. 62 Dimensions: L 62 mm - H 46 mm

RÉF. 608

Tailles 52 - 54 - 56 - 58 - 60 - 62.

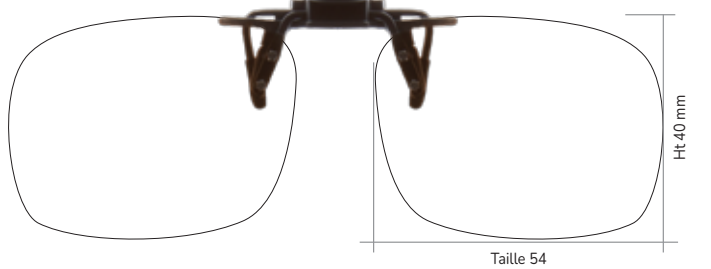

TAILLE

T. 52 Dimensions: L 52 mm - H 38 mm
T. 54 Dimensions: L 54 mm - H 40 mm
T. 56 Dimensions: L 56 mm - H 42 mm

T. 58 Dimensions: L 58 mm - H 44 mm
T. 60 Dimensions: L 60 mm - H 46 mm
T. 62 Dimensions: L 62 mm - H 48 mm

RÉF. 609

Tailles 50 - 52 - 54 - 56 - 58 - 60 - 62.

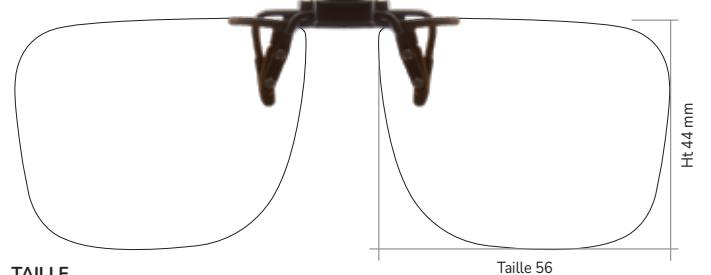

TAILLE

T. 50 Dimensions: L 50 mm - H 38 mm
T. 52 Dimensions: L 52 mm - H 40 mm
T. 54 Dimensions: L 54 mm - H 42 mm
T. 56 Dimensions: L 56 mm - H 44 mm

T. 58 Dimensions: L 58 mm - H 46 mm
T. 60 Dimensions: L 60 mm - H 48 mm
T. 62 Dimensions: L 62 mm - H 50 mm

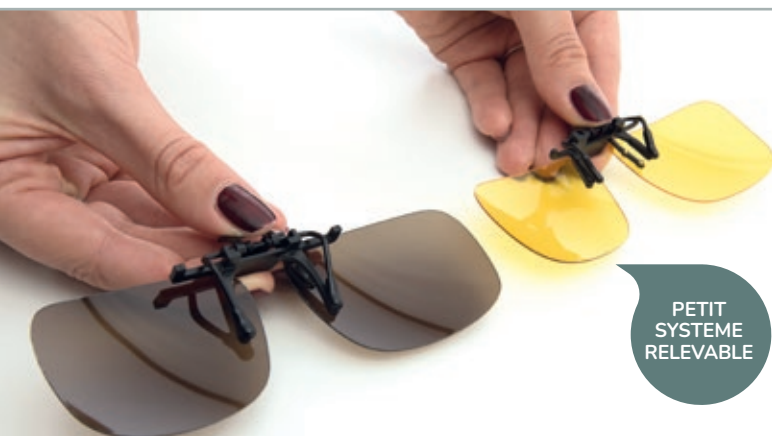

PETIT
SYSTEME
RELEVABLE



RÉF. 610

Tailles 46 - 48 - 50 - 52 - 54 - 56.

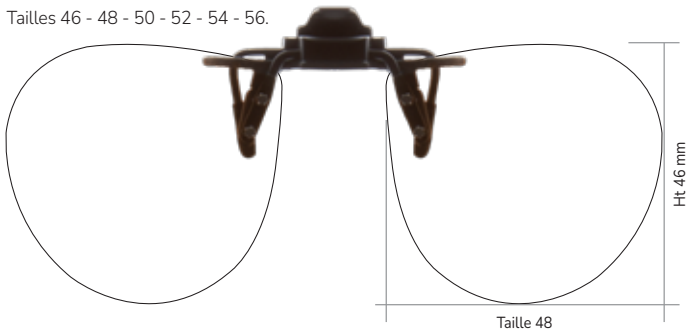

- T. 46 Dimensions: L 46 mm - H 44 mm
- T. 48 Dimensions: L 48 mm - H 46 mm
- T. 50 Dimensions: L 50 mm - H 48 mm

- T. 52 Dimensions: L 52 mm - H 50 mm
- T. 54 Dimensions: L 54 mm - H 52 mm
- T. 56 Dimensions: L 56 mm - H 54 mm

RÉF. 611

Tailles 51 - 53 - 55 - 57 - 59 - 61.

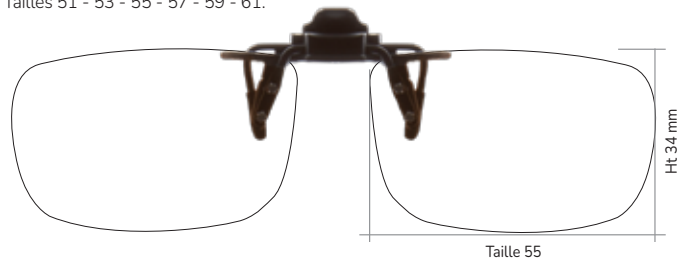

- TAILLE**
- T. 51 Dimensions: L 51 mm - H 30 mm
 - T. 53 Dimensions: L 53 mm - H 32 mm
 - T. 55 Dimensions: L 55 mm - H 34 mm

- T. 57 Dimensions: L 57 mm - H 36 mm
- T. 59 Dimensions: L 59 mm - H 38 mm
- T. 61 Dimensions: L 61 mm - H 40 mm

RÉF. 612

Tailles 55 - 57 - 60 - 62.

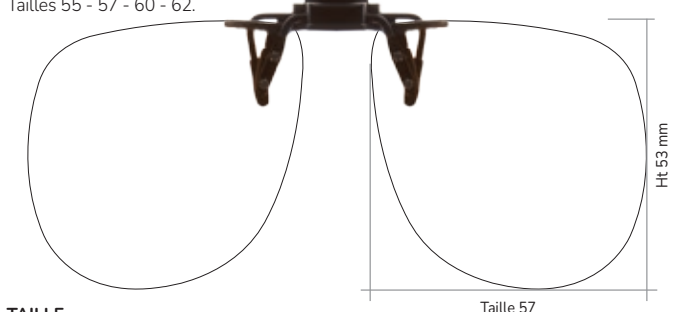

- TAILLE**
- T. 55 Dimensions: L 55 mm - H 51 mm
 - T. 57 Dimensions: L 57 mm - H 53 mm

- T. 60 Dimensions: L 60 mm - H 55 mm
- T. 62 Dimensions: L 62 mm - H 57 mm



Disponible dans tous les verres figurant ci-dessous

POLARISANT TAC

(<0.75 mm découppable aux ciseaux)



EASYCLIP

FACES RELEVABLES POLARISANTES

Avec étui souple. **Minimum 6 pièces au choix.**
Possibilité de panacher dans les références.



POLARISANT TAC

- MC CAT3
- G15 CAT3
- G15 CAT3
- JAUNE CAT1



Systeme relevable
(Minimum 6 pièces)



Étui souple

RÉF. 713Q

Polarisant brun cat. 3.

POLARISANT TAC

- MC CAT3



RÉF. 713S

Polarisant G15 cat. 3.

POLARISANT TAC

- G15 CAT3



RÉF. 715Q

Polarisant brun. cat. 3.

POLARISANT TAC

- MC CAT3

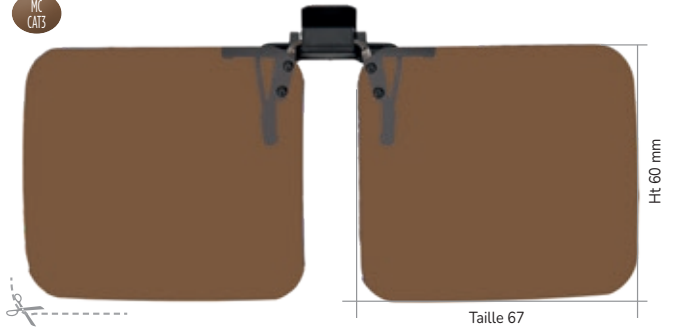

RÉF. 715S

Polarisant G15 cat. 3.

POLARISANT TAC

- G15 CAT3



RÉF. 714S

Polarisant G15 cat. 3.

POLARISANT TAC

- G15 CAT3



RÉF. 714Q

Polarisant brun cat. 3.

POLARISANT TAC

- MC CAT3



RÉF. 716S

Polarisant G15 cat. 3.

POLARISANT TAC

- G15 CAT3

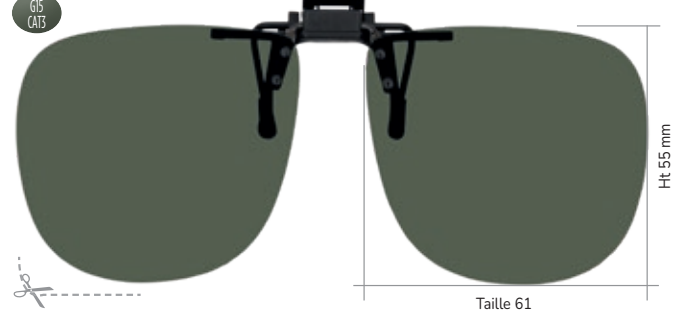

RÉF. 716Q

Polarisant brun cat. 3.

POLARISANT TAC

- MC CAT3



RÉF. 716T

Polarisant jaune cat. 1.

POLARISANT TAC

- JAUNE CAT1



RÉF. 716R

Polarisant gris cat. 3.

POLARISANT TAC

- G15 CAT3



SPÉCIAL
CONDUITE
DE NUIT,
SPORT

confort pour
la conduite



BASSE VISION

450 nm, 511 nm, 527 nm, 550 nm



LES FILTRES

Ils sont utilisés pour donner un meilleur confort visuel, accentuer les contrastes et réduire l'éblouissement. Pour cela ils filtrent les parties gênantes à ondes courtes et les U.V. de la lumière du jour.



Verre: 450 NM
CAT1
Code:

Bloque la lumière sous 450 nm.
Couleur: jaune.

Indications:

- Dégénérescence maculaire.
- Atrophie du nerf optique.



Verre: 511 NM
CAT1
Code: H

Bloque la lumière sous 511 nm.
Couleur: jaune-orangé.

Indications:

- Dégénérescence maculaire.
- Atrophie du nerf optique.
- Glaucome.
- Cataracte.
- Rétinite pigmentaire.



Verre: 527 NM
CAT1
Code:

Bloque la lumière sous 527 nm.
Couleur: rouge-orangé.

Indications:

- Glaucome.
- Cataracte.
- Rétinite pigmentaire.
- Rétinopathie diabétique.



Verre: 550 NM
CAT2
Code: Y

Bloque la lumière sous 550 nm.
Couleur: rouge.

Indications:

- Rétinite pigmentaire.

FASTCLIP RELEVABLES BASSE VISION

Montage vissé. Avec étui rigide.

115

Tailles 50 - 52 - 54 - 56 - 58 - 60.



129

Tailles 52 - 54 - 56 - 58 - 60.



116

Tailles 55 - 57 - 60.



132

Tailles 52 - 54 - 56 - 58 - 60.



VERRES AU CHOIX



DÉCOUVREZ TOUS LES MODÈLES de faces relevables pages 12

CLIP - ON REGLABLES BASSE VISION

Avec étui rigide.

121

Tailles 44 - 46 - 48 - 50 - 52 - 54 - 56.



DÉCOUVREZ TOUS LES MODÈLES de clip-on réglables pages 10

131

Tailles 52 - 54 - 56 - 58.

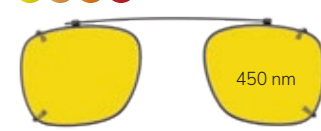

VERRES AU CHOIX

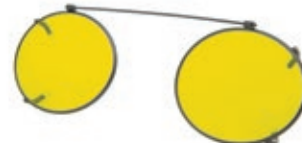

SURLUNETTES BASSE VISION

Avec verres au choix. Avec étui rigide.

RÉF. 315

Monture noire. Taille 55-22.



RÉF. 316

Monture noire. Taille 61-18.



RÉF. 326N

Monture noire. Taille 65-16.



VERRES AU CHOIX



DÉCOUVREZ TOUS LES MODÈLES de lunettes pages 18

LUNETTES BASSE VISION

Avec verres au choix. Avec étui rigide.

RÉF. 100

Monture métal noire, gun et marron. Branches flex. Taille 56-15.



RÉF. 69

Monture plastique noire. Taille 55-17.



RÉF. 1014

Monture plastique noire. Branches métal. Taille 55-17.



RÉF. 90

Monture plastique noire et ecaille. Taille 47-20.



LUNETTES

Lunettes avec verres au choix.
Avec pochette tissu.



Réf. 90



Réf. 93



Choisissez vos verres



Pochette tissu

RÉF. 100

Monture métal noire, gun et marron.
Branches flex. Taille 56-15.



Verre Blue-blocker (AY):
réduit la fatigue de l'œil
sur tous types d'écrans.



Gun

Anti-lumière bleue



Marron

Antiphare

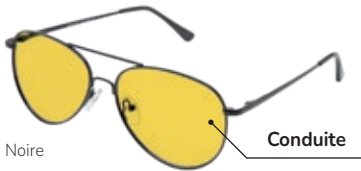

Noire

Conduite



RÉF. 69

Monture plastique noire.
Taille 55-17.



Anti-lumière bleue

RÉF. 84

Monture plastique noire.
Taille 49-20.



Antiphare



RÉF. 1014

Monture plastique noire.
Branches métal. Taille 55-17.



Antiphare



Verre Jaune Antiphare (W):
pour la conduite de nuit.
Atténue l'éblouissement
des phares.

RÉF. 90

Monture plastique noire et ecaille.
Taille 47-20.



Noire

Conduite



Ecaille

Anti-lumière bleue



RÉF. 91

Monture plastique marron.
Taille 47-18.



LUNETTES DE PROTECTION



RÉF. 93

Monture plastique bleue ou grise.
Taille 48-20.



Bleue



Grise

RÉF. 314B

Incolore.



RÉF. 314G

Gris cat. 3.



RÉF. 96

Monture plastique noire.
Taille 50-16.



Antiphare

RÉF. 317

Lunettes de protection pour verres correcteurs.
Taille 57-16.



RÉF. 1024

Monture plastique noire.
Taille 56-18.

JAUNE CAT0

Verre Jaune (AS):
pour la conduite, tir, ski.
Augmente le contraste
et la luminosité.



Conduite

RÉF. 318

Lunettes de protection avec clip pour verres correcteurs.



Disponible dans tous les verres figurant ci-dessous

POLYC.



AR

ORGANIQUE



AL



AC



AD



AS



X



Z



O



W



AM



AN



F



L



M



N



P

BASSE VISION ORGANIQUE



G



H



I



Y

ORGANIQUE BLUE-BLOCKER (LUMIÈRE BLEUE)



AY

CHAÎNETTES

RÉF. 225

Chaînettes fines métal gun.
Mini 6 pièces
(6 maillons différents).



RÉF. 227

Chaînettes métal
couleur boule fine.
Mini 6 pièces
(une de chaque couleur).

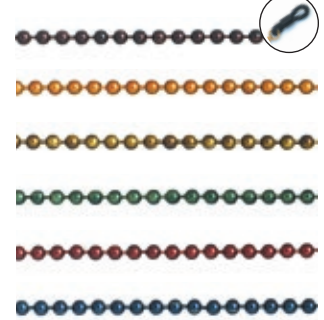

Marron
Jaune
Vert clair
Vert foncé
Rouge
Bleu

RÉF. 226

Chaînettes fines métal doré.
Mini 6 pièces
(6 maillons différents).



RÉF. 228

Chaînettes métal couleur.
Mini 6 pièces
(une de chaque couleur).

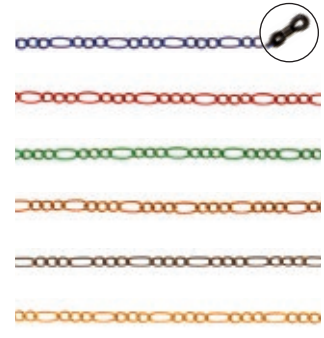

Bleu
Rouge
Vert
Ocre
Marron
Jaune

RÉF. 229

Chaînettes métal couleur
cylindre.
Mini 6 pièces
(une de chaque couleur).

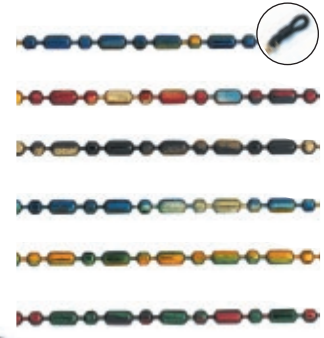

Bleu
Rouge
Vert
Rouille
Marron foncé
Marron clair

RÉF. 230

Chaînettes métal or et argent.
Mini 6 pièces
(trois de chaque couleur).



RÉF. 232

Chaînettes perles bois fantaisie.
Mini 6 pièces
(6 modèles différents).



RÉF. 158

Chaînettes perle grain de riz.
Mini 6 pièces.



Perle ivoire et argent



CORDONS

RÉF. 000

Cordon Polyamide Ø 2mm. Mini 12 pièces.



Noir

RÉF. 001

Cordon Polyamide Ø 2mm. Mini 12 pièces.



Marron

RÉF. 003

Cordon Polyamide Ø 2mm. Panaché de 6 couleurs. Mini 12 pièces (2 de chaque couleur).



Bleu



Bordeaux



Vert



Gris



Noir



Rouge

RÉF. 017

Cordon Satiné Ø 1.2mm. Mini 6 pièces coloris au choix.



Noir



Marron clair



Bordeaux

RÉF. 018

Cordon élastique Ø 3mm. Mini 12 pièces (6 noir, 6 marron).



Noir



Marron

RÉF. 010

Cordon Polyamide. Compact Ø 2mm. Caoutchouc Remplaçable. Mini 6 pièces coloris au choix.



Noir



Bleu Marine



Marron



Gris



Bordeaux

RÉF. 9119

Cordon coton ciré Ø 2mm. Mini 12 pièces (4 noir, 4 brun, 4 beige foncé).



Noir



Brun



Beige foncé

CORDONS JUNIOR

RÉF. 9135 ETOILE

Cordon élastique soft couleur Ø 2mm ajustable avec motif. Mini 12 pièces.



RÉF. 9136 POMME

Cordon élastique soft couleur Ø 2mm ajustable avec motif. Mini 12 pièces.



RÉF. 9072 ANIMAUX

Corde tressé polyamide couleur Ø 1.5mm ajustable avec motif. Mini 12 pièces.



RÉF. 9073 MICKEY

Corde tressé polyamide couleur Ø 1.5 mm ajustable avec motif. Mini 12 pièces.



RÉF. 9075 BALLON

Corde tressé polyamide couleur Ø 1.5mm ajustable avec motif. Mini 12 pièces.



CORDONS SPORT

RÉF. 704

Bandeau néoprène uni. Mini 12 pièces. Coloris au choix.

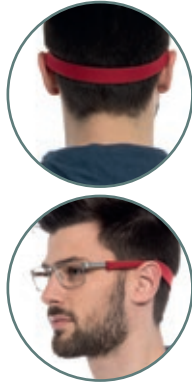
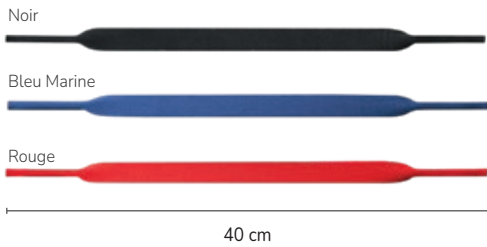

RÉF. 705

Cordon silicone. Mini 12 pièces. (2 de chaque couleur).



RÉF. 706

Cordons flotteurs. Mini 12 pièces. (4 bleu, 4 noir, 2 jaune fluo, 2 rose fluo).

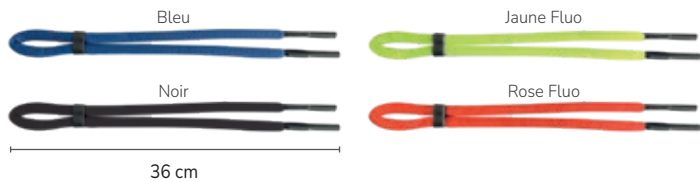

RÉF. 255

Chaussette lycra ajustable. Mini 12 pièces. (4 de chaque couleur).

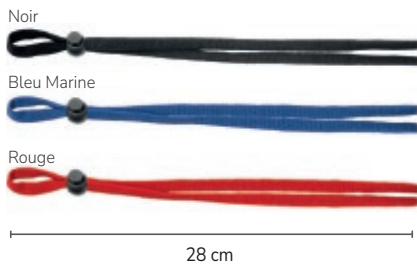

RÉF. 256

Mini 12 pièces. (4 de chaque couleur).



PRÉSENTOIR



LUNETTES MAQUILLAGE



Étui rigide

RÉF. 301

Monture plastique flex.
Verre basculant de droite à gauche.
Avec étui souple.
(+1.50/+2.00/+2.50/+3.00)



RÉF. 8904

Monture métal flex dorée.
Possibilité de changer les verres.
Avec étui souple.
(+1.50/+2.00/+2.50/+3.00/+3.50)



RÉF. 9121

Monture métal flex.
Possibilité de changer les verres.
Avec étui souple.
(+2.00/+2.50/+3.00/+3.50)



LUNETTES LOUPE

RÉF. 3305

50-20. Lunettes loupe face plastique. Branche métal plastique flex.
(+1,50/+2,00/+2,50/+3,00/+3,50/+4,00)

Ecaillé



Noire

Avec étui

RÉF. RG04

50-20. Monture métal flex.
(+1,00/+1,50/+2,00/+2,50/+3,00/+3,50/+4,00)



Gun



Bleue

Marron



RÉF. 10127

50-15. Lunettes loupe métal branche plastique avec perle.
(+1,50/+2,00/+2,50/+3,00/+3,50)

Mauve



Argent

Noire



RÉF. 139

Face relevable correctrice. Avec étui souple.
(+1,50/+2,00/+2,50/+3,00)



Ht 50 mm

Taille 59



RÉF. 140

Face relevable correctrice. Avec étui souple.
(+1,50/+2,00/+2,50/+3,00)



Ht 31 mm

Taille 56



RÉF. 10196

50-15. Lunettes loupe métal nylon.
(+1,50/+2,00/+2,50/+3,00/+3,50)

Noire



Brun

Violet



RÉF. PR250

Protections latérales en cuir noir (paire).



RÉF. 10203

50-15. Lunettes loupe métal branche vitrail.
(+1,50/+2,00/+2,50/+3,00/+3,50)

Brun



Mauve

Bordeaux



Votre commande sur www.jhbuffard.com

VOUS POUVEZ COMMANDER DIRECTEMENT À PARTIR DE NOTRE SITE WEB

Sur notre site vous trouverez le plus grand choix de clips solaires.
Service pour les professionnels.



- 1 Inscrivez-vous dans l'onglet s'enregistrer en renseignant vos coordonnées, vous recevrez une confirmation sur votre messagerie.
- 2 L'identifiant ou login est votre adresse e-mail et le mot de passe est celui que vous avez choisi lors de votre inscription.
- 3 Si mot de passe perdu : faire mot de passe oublié.

S'ENREGISTRER

Entreprise*

TVA*

Prénoms*

CONNEXION

Utilisateur*

Mot de passe*

Rester connecté

LOG IN

En cliquant sur Enregistrer, vous acceptez les Conditions d'utilisation...

REGISTRER

Log In Mot de passe perdu

- 4 Concernant le règlement : si vous êtes affilié à une CENTRALE veuillez préciser le NOM DE LA CENTRALE et VOTRE NUMERO D'ADHERENT dans les notes.
- 5 Si vous n'êtes pas adhérent à une centrale nous adresser le règlement à 30 jours net.

Notes de commande (facultatif)

Commentaires concernant votre commande, ex. : conditions de livraison.

Virement

Nous avons bien reçu votre commande et nous vous en remercions.
Après réception de la marchandise, vous avez 30 jours pour faire le règlement ou régler comptant avec escompte de 1% sous 7 jours date facture.



- Avant de passer une commande: 1) Bien vérifier la taille de la monture client.
2) Les clip-on, faces solaires et lunettes en cat. 0-1-2-4, Basse Vision et Base 8 sont réalisés sur commande et ne sont ni repris, ni échangés.
3) Les prix des clip-on et faces relevables sont en cat. 3.

GARANTIE: nos produits sont garantis un an contre tout vice de fabrication à compter de la date de livraison.
RETOUR MARCHANDISE: dans un délai de 7 jours à compter de la date de livraison.

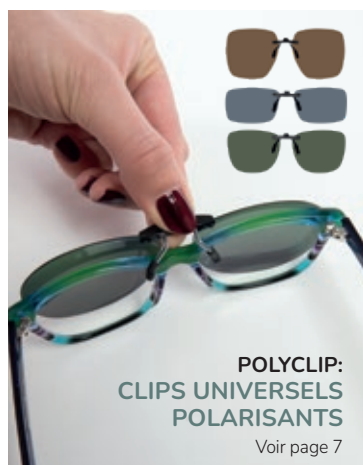

Téléphone: 04 94 39 69 47
(de 8 h 30 à 17 h 30 du lundi au vendredi)
Adresse: 1328, Avenue de Montferrat, Impasse de la Valérie
83300 DRAGUIGNAN
Internet: www.jhbuffard.com / info@jhbuffard.com
commande@jhbuffard.com / sav@jhbuffard.com

SARL au capital de 120 000€
TVA INTRACOM: FR 11 385 409 453
R.C.S. DRAGUIGNAN: 385 409 453 (2007 B 460)
SIRET: 385 409 453 00060 APE: 3250B

Votre commande sur www.jhbuffard.com - Téléphone: 04 94 39 69 47